

Price List
Fiyat Listesi
2024



HAKKIMIZDA ABOUT US

1975 yılında Hasan TAMER tarafından Ankara'da elektrik dağıtım tesisatında kullanılan sac ürünleri imalatı ile iş hayatına başlamıştır. 1980 yılına kadar süren sac imalatı sonrası, hali hazırda devam etmekte olan elektrik sarf malzemelerinin toptan ve perakende satışlarını sürdürmektedir.

1995 yılında Ostim 'de imalat çalışmalarına başlanmış ve bugün Sarayköy-Kahramankazan'da 8200 m2 kapalı alanında üretimlerine devam etmektedir. Yapısında seçkin kadrosuyla 1995 yılından günümüze üretimde çeşitliliğe gidilmiş, bu kapsamda 2000 yılında ISO 9001 Kalite Yönetim Sistemi belgesini bünyesine kazandırmıştır. Akabinde 2007 de ISO 14001 Çevre Yönetim Sistemi belgesini, 2014'te ISO 45001 İş Sağlığı ve Güvenliği Yönetim Sistemi belgesi, 2023'te ISO 10002 Müşteri Memnuniyeti Yön. Sistemi ve ISO 27001 Bilgi Güvenliği Yön. Sistemi, RoHS belgeleri, TSE ürün belgeleri, CE belgeleri ve ürünler ile ilgili uluslararası test belgelerini bulundurmaktadır.

Ürün gamında; Alçak ve Orta gerilim sınıfı dahilinde; reçineli, ısı büzüşmeli kablo ek muflarını, reçineli, ısı büzüşmeli ve silikon kablo başlıklarını, sıkmalı kablo pabuçları, sıkmalı ek mufları, Protolin ve ProSil yalıtım sıvılarını, AG&OG Buşing ve VHD kapama, havai hat izolasyon kapama malzemelerini üretmektedir. 2011 yılı başı ile Türkiye'de bir ilk olan "Isı Büzüşmeli Boru" üretimine geçerek bir ilki gerçekleştirmiş ve Türkiye için ufak, kendi için büyük bir yeniliğe imza atmıştır.

2018 yılında TAMGRUP ışınlama tesisini faaliyete alarak, Türkiye'de elektron hızlandırıcı (e-beam) tesisi kurarak yerli üretimde ki gücünü ve yerli üretime olan katkısını artırmıştır. Yalıtım alanında, kablo eklerinde, kablo başlıklarında ve aksesuarları üretiminde kaliteden taviz vermeden, müşteri memnuniyetinin üst seviyede tutulması ilkesine olan bağlılığını sürdürmeye devam edecektir.



The company was founded by Hasan TAMER in Ankara in 1975 for the manufacturing of metal sheet products used in electricity distribution networks. After the manufacturing of metal sheets which continued until the year 1980, the company has started dealing with the wholesale and retail marketing of the electricity products which is still continuing today.

The manufacturing works were started in 1995 in Ostim and now it is continuing in Sarayköy-Kahramankazan within a closed area of 8200 m2. The variety of the range of products has been given utmost care by the expert staff from the year 1995 and in this respect; ISO 9001 Quality certificate was received by the company and pursuant to this ISO 9001 Environmental Management System certificate was received in 2007, ISO 45001 Occupational Health and Safety Management System certification received in 2014, ISO 10002 Customer Satisfaction and Information Security Mng. System received in 2023 and the company also has RoHS documents, all TSE Product certificates, CE certificates, international test reports for products.

The product range of the company is composed of; Low and medium voltage class, resin, heat shrinkable cable joints and resin, heat shrinkable and silicon terminations, compressive cable lugs, compressive cable connectors, Protolin and ProSil insulation fluids, LV & MV Bushing and VHD covering, overhead-line protection. By the beginning of the year 2011, the company started the manufacturing of "heat shrinkable tubes" which was an innovation and has taken a small step for Turkey but a large step for itself. The irradiation facility TAMGRUP taking activities in 2018, the power of the electron accelerator by establishing local production facilities in Türkiye and increased its contribution to domestic production.

The company will always fulfill its principle of keeping the customer satisfaction at utmost level without ignoring the quality in the sector of insulation and in manufacturing of the cable end sleeves and accessories.





Reçineli Ek Mufları

04

Protolinler

22

İzolasyon Kapamalar

23

Isı Büzüşmeli Ek Muflar

26

AG Kablo Başlıkları

52

OG Isı Büzüşmeli Kablo Başlıkları

64

Silikon Kablo Başlıkları

80

SKP & SEM

86

Isı Büzüşmeli Borular

92

Aksesuarlar

98

KOD CODE	KABLO KESİTİ CROSS SECTION	ADET/KOLİ UNIT/BOX	FİYAT PRICE
E1 4105 - E1 4205	4 x 1,5 - 4 x 2,5	60	410,00 ₺
E1 404 - E1 406	4 x 4 - 4 x 6	60	410,00 ₺
E1 515 - E1 525	5 x 1,5 - 5 x 2,5	60	450,00 ₺
E1 504 - E1 506	5 x 4 - 5 x 6	60	450,00 ₺
E1 715 - E1 725	7 x 1,5 - 7 x 2,5	60	685,00 ₺

0.6-1 kV



KOD CODE	KABLO KESİTİ CROSS SECTION	ADET/KOLİ UNIT/BOX	FİYAT PRICE
E1 215 - E1 204	2 x 1,5 - 2 x 4	60	375,00 ₺
E1 206	2 x 6	60	375,00 ₺
E1 210	2 x 10	27	595,00 ₺
E1 216 - E1 225	2 x 16 - 2 x 25	27	595,00 ₺
E1 235 - E1 250	2 x 35 - 2 x 50	27	655,00 ₺
E1 270 - E1 295	2 x 70 - 2 x 95	12	895,00 ₺
E1 2120 - E1 2150	2 x 120 - 2 x 150	12	1.595,00 ₺
E1 2185	2 x 185	4	1.662,00 ₺
E1 2240	2 x 240	4	1.805,00 ₺

0.6-1 kV



KOD CODE	KABLO KESİTİ CROSS SECTION	ADET/KOLİ UNIT/BOX	FİYAT PRICE
E1 115 - E1 104	1 x 1,5 - 1 x 4	60	365,00 ₺
E1 106	1 x 6	60	365,00 ₺
E1 110	1 x 10	60	430,00 ₺
E1 116- 125	1 x 16 - 1 x 25	60	430,00 ₺
E1 135 -E1 150	1 x 35 - 1 x 50	60	470,00 ₺
E1 170 - E1 195	1 x 70 - 1 x 95	60	500,00 ₺
E1 1120 - E1 1150	1 x 120 - 1 x 150	40	665,00 ₺
E1 1185	1 x 185	40	830,00 ₺
E1 1240	1 x 240	40	860,00 ₺
E1 1300	1 x 300	24	1.110,00 ₺
E1 1400	1 x 400	24	1.165,00 ₺
E1 1500	1 x 500	24	1.450,00 ₺

0.6-1 kV

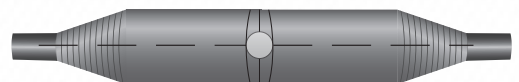

* İstenilen Kablo Kesitlerine Göre Ek Yapılır. / * Produce Joint According To Demand

BAKIR İLETKENLER İÇİN REÇİNELİ KABLO EK MUFLARI

FOR COPPER CONNECTORS RESIN CABLE JOINT

KOD CODE	KABLO KESİTİ CROSS SECTION	ADET/KOLİ UNIT/BOX	FİYAT PRICE
E1 410	4 x 10	27	625,00 ₺
E1 416	4 x 16	27	635,00 ₺
E1 31610	3 x 16 + 10	27	635,00 ₺
E1 32516	3 x 25 + 16	27	665,00 ₺
E1 33516	3 x 35 + 16	27	700,00 ₺
E1 35025	3 x 50 + 25	27	720,00 ₺
E1 425	4 x 25	27	680,00 ₺
E1 435	4 x 35	27	710,00 ₺
E1 450	4 x 50	27	740,00 ₺
E1 510 - E1 516	5 x 10 - 5 x 16	27	665,00 ₺

0.6-1 kV



KOD CODE	KABLO KESİTİ CROSS SECTION	ADET/KOLİ UNIT/BOX	FİYAT PRICE
E1 315 - E1 304	3 x 1,5 - 3 x 4	60	390,00 ₺
E1 306	3 x 6	60	390,00 ₺
E1 310	3 x 10	27	600,00 ₺
E1 316	3 x 16	27	615,00 ₺
E1 325	3 x 25	27	630,00 ₺
E1 335	3 x 35	27	665,00 ₺
E1 350	3 x 50	27	685,00 ₺

0.6-1 kV

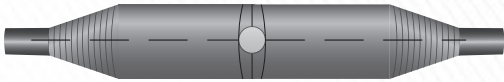

KOD CODE	KABLO KESİTİ CROSS SECTION	ADET/KOLİ UNIT/BOX	FİYAT PRICE
E1 37035	3 x 70 + 35	12	1.165,00 ₺
E1 39550	3 x 95 + 50	12	1.220,00 ₺
E1 470	4 x 70	12	1.100,00 ₺
E1 495	4 x 95	12	1.250,00 ₺
E1 525	5 x 25	12	1.170,00 ₺
E1 535	5 x 35	12	1.190,00 ₺
E1 550	5 x 50	12	1.220,00 ₺

0.6-1 kV



KOD CODE	KABLO KESİTİ CROSS SECTION	ADET/KOLİ UNIT/BOX	FİYAT PRICE
E1 370	3 x 70	12	1.150,00 ₺
E1 395	3 x 95	12	1.205,00 ₺

0.6-1 kV



KOD CODE	KABLO KESİTİ CROSS SECTION	ADET/KOLİ UNIT/BOX	FİYAT PRICE
E1 31207	3 x 120 + 70	10	1.940,00 ₺
E1 31507	3 x 150 + 70	10	2.030,00 ₺
E1 4120	4 x 120	10	2.020,00 ₺
E1 4150	4 x 150	10	2.105,00 ₺
E1 570	5 x 70	10	1.950,00 ₺
E1 595	5 x 95	10	2.030,00 ₺

0.6-1 kV

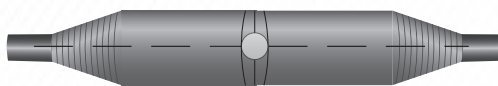

BAKIR İLETKENLER İÇİN REÇİNELİ KABLO EK MUFLARI

FOR COPPER CONNECTORS RESIN CABLE JOINT

KOD CODE	KABLO KESİTİ CROSS SECTION	ADET/KOLİ UNIT/BOX	FİYAT PRICE
E1 3120	3 x 120	10	1.920,00 ₺
E1 3150	3 x 150	10	2.000,00 ₺

0.6-1 kV



KOD CODE	KABLO KESİTİ CROSS SECTION	ADET/KOLİ UNIT/BOX	FİYAT PRICE
E1 31859	3 x 185 + 95	4	2.995,00 ₺
E1 32401	3 x 240 + 120	4	3.215,00 ₺
E1 4185	4 x 185	4	3.075,00 ₺
E1 4240	4 x 240	4	3.290,00 ₺
E1 5120	5 x 120	4	3.000,00 ₺
E1 5150	5 x 150	4	3.100,00 ₺

0.6-1 kV

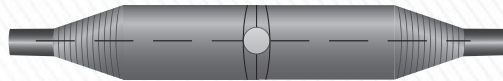

KOD CODE	KABLO KESİTİ CROSS SECTION	ADET/KOLİ UNIT/BOX	FİYAT PRICE
E1 3185	3 x 185	4	2.975,00 ₺
E1 3240	3 x 240	4	3.200,00 ₺

0.6-1 kV





0.6-1 kV



0.6-1 kV

KOD CODE	KABLO KESİTİ CROSS SECTION	ADET/KOLİ UNIT/BOX	FİYAT PRICE
AE1 4105 - AE1 4205	4 x 1,5 - 4 x 2,5	60	390,00 ₺
AE1 404 - AE1 406	4 x 4 - 4 x 6	60	390,00 ₺
AE1 515 - AE1 525	5 x 1,5 - 5 x 2,5	60	430,00 ₺
AE1 504 - AE1 506	5 x 4 - 5 x 6	60	430,00 ₺
AE1 715 - AE1 725	7 x 1,5 - 7 x 2,5	60	670,00 ₺

KOD CODE	KABLO KESİTİ CROSS SECTION	ADET/KOLİ UNIT/BOX	FİYAT PRICE
AE1 215 - AE1 204	2 x 1,5 - 2 x 4	60	360,00 ₺
AE1 206	2 x 6	60	360,00 ₺
AE1 210	2 x 10	27	585,00 ₺
AE1 216 - AE1 225	2 x 16 - 2 x 25	27	595,00 ₺
AE1 235 - AE1 250	2 x 35 - 2 x 50	27	645,00 ₺
AE1 270 - AE1 295	2 x 70 - 2 x 95	12	885,00 ₺
AE1 2120 - AE1 2150	2 x 120 - 2 x 150	12	1.585,00 ₺
AE1 2185	2 x 185	4	1.655,00 ₺
AE1 2240	2 x 240	4	1.795,00 ₺

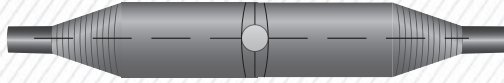

0.6-1 kV



0.6-1 kV

KOD CODE	KABLO KESİTİ CROSS SECTION	ADET/KOLİ UNIT/BOX	FİYAT PRICE
AE1 410	4 x 10	27	610,00 ₺
AE1 416	4 x 16	27	630,00 ₺
AE1 31610	3 x 16 + 10	27	620,00 ₺
AE1 510 - E1 516	5 x 10 - 5 x 16	27	645,00 ₺

KOD CODE	KABLO KESİTİ CROSS SECTION	ADET/KOLİ UNIT/BOX	FİYAT PRICE
AE1 115 - AE1 104	1 x 1,5 - 1 x 4	60	355,00 ₺
AE1 106	1 x 6	60	355,00 ₺
AE1 110	1 x 10	60	420,00 ₺
AE1 116-125	1 x 16 - 1 x 25	60	420,00 ₺
AE1 135 -AE1 150	1 x 35 - 1 x 50	60	490,00 ₺
AE1 170 - AE1 195	1 x 70 - 1 x 95	60	490,00 ₺
AE1 1120 - AE1 1150	1 x 120 - 1 x150	40	650,00 ₺
AE1 1185	1 x 185	40	820,00 ₺
AE1 1240	1 x 240	40	850,00 ₺
AE1 1300	1 x 300	24	1.095,00 ₺
AE1 1400	1 x 400	24	1.130,00 ₺
AE1 1500	1 x 500	24	1.240,00 ₺

ALÜMİNYUM İLETKENLER İÇİN REÇİNELİ KABLO EK MUFLARI

FOR ALUMINUM CONNECTORS RESIN CABLE JOINT



0.6-1 kV



0.6-1 kV

KOD CODE	KABLO KESİTİ CROSS SECTION	ADET/KOLİ UNIT/BOX	FİYAT PRICE
AE1 32516	3x25+16	27	650,00 ₺
AE1 33516	3x35+16	27	685,00 ₺
AE1 35025	3x50+25	27	710,00 ₺
AE1 425	4x25	27	670,00 ₺
AE1 435	4x35	27	710,00 ₺
AE1 450	4x50	27	725,00 ₺

KOD CODE	KABLO KESİTİ CROSS SECTION	ADET/KOLİ UNIT/BOX	FİYAT PRICE
AE1 325	3 x 25	27	620,00 ₺
AE1 335	3 x 35	27	650,00 ₺
AE1 350	3 x 50	27	670,00 ₺

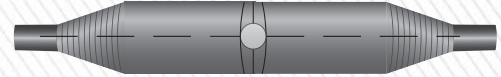

0.6-1 kV



0.6-1 kV

KOD CODE	KABLO KESİTİ CROSS SECTION	ADET/KOLİ UNIT/BOX	FİYAT PRICE
AE1 525	5 x 25	12	1.170,00 ₺
AE1 535	5 x 35	12	1.180,00 ₺
AE1 550	5 x 50	12	1.210,00 ₺

KOD CODE	KABLO KESİTİ CROSS SECTION	ADET/KOLİ UNIT/BOX	FİYAT PRICE
AE1 370	3 x 70	12	1.125,00 ₺
AE1 395	3 x 95	12	1.150,00 ₺

KOD CODE	KABLO KESİTİ CROSS SECTION	ADET/KOLİ UNIT/BOX	FİYAT PRICE
AE1 37035	3 x 70 + 35	12	1.355,00 ₺
AE1 39550	3 x 95 + 50	12	1.410,00 ₺
AE1 31207	3 x 120 + 70	10	2.015,00 ₺
AE1 31507	3 x 150 + 70	10	2.015,00 ₺
AE1 470	4 x 70	12	1.695,00 ₺
AE1 495	4 x 95	12	1.780,00 ₺
AE1 4120	4 x 120	10	2.005,00 ₺
AE1 4150	4 x 150	10	2.095,00 ₺
AE1 570	5 x 70	10	1.940,00 ₺
AE1 595	5 x 95	10	2.020,00 ₺

0.6-1 kV

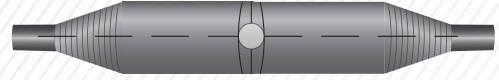

KOD CODE	KABLO KESİTİ CROSS SECTION	ADET/KOLİ UNIT/BOX	FİYAT PRICE
AE1 3120	3 x 120	10	1.885,00 ₺
AE1 3150	3 x 150	10	1.990,00 ₺

0.6-1 kV



KOD CODE	KABLO KESİTİ CROSS SECTION	ADET/KOLİ UNIT/BOX	FİYAT PRICE
AE1 31859	3 x 185 + 95	4	2.970,00 ₺
AE1 32401	3 x 240 + 120	4	3.120,00 ₺
AE1 4185	4 x 185	4	3.060,00 ₺
AE1 4240	4 x 240	4	3.210,00 ₺
AE1 5120	5 x 120	4	3.000,00 ₺
AE1 5150	5 x 150	4	3.085,00 ₺

0.6-1 kV



KOD CODE	KABLO KESİTİ CROSS SECTION	ADET/KOLİ UNIT/BOX	FİYAT PRICE
AE1 3185	3 x 185	4	2.950,00 ₺
AE1 3240	3 x 240	4	3.090,00 ₺

0.6-1 kV



REÇİNELİ KABLO EK MUFLARI

*Güç yalıtımlı bağlantılarda,
yer altı, yer üstü enerji kabloları,
ve telefon bağlantısında
güvenilir çözüm*



KOD CODE	KABLO KESİTİ CROSS SECTION	KOLİ ADETİ UNIT / BOX	FİYAT PRICE
ŞE1 410	4 x 10	40	612,00 ₺
ŞE1 416	4 x 16	40	612,00 ₺
ŞE1 425	4 x 25	40	640,00 ₺
ŞE1 31610	3 x 16 +10	40	610,00 ₺
ŞE1 32516	3 x 25 +16	40	625,00 ₺
ŞE1 1015 - ŞE1 1025	10 x 1,5 - 10 x 2,5	40	765,00 ₺
ŞE1 1004 - ŞE1 1006	10 x 4 - 10 x 6	40	765,00 ₺



KOD CODE	KABLO KESİTİ CROSS SECTION	KOLİ ADETİ UNIT / BOX	FİYAT PRICE
ŞE1 435	4 x 35	20	1.480,00 ₺
ŞE1 450	4x50	20	1.480,00 ₺
ŞE1 470	4 x 70	20	1.530,00 ₺
ŞE1 495	4 x 95	20	1.565,00 ₺
ŞE1 33516	3 x 35 + 16	20	1.460,00 ₺
ŞE1 35025	3 x 50 + 25	20	1.490,00 ₺
ŞE1 37035	3 x 70 + 35	20	1.595,00 ₺
ŞE1 39550	3 x 95 + 50	20	1.510,00 ₺
ŞE1 2415 - ŞE1 2425	24 x 1,5 - 24 x 2,5	20	1.545,00 ₺



KOD CODE	KABLO KESİTİ CROSS SECTION	Y. ÇIKIŞ KESİTİ BRANCH SECTION	FİYAT PRICE
YE1 11015	1 x 10	1 x 1,5	520,00 ₺
YE1 11615	1 x 16	1 x 1,5	520,00 ₺
YE1 12516	1 x 25	1 x 16	555,00 ₺
YE1 13525	1 x 35	1 x 25	555,00 ₺
YE1 15035	1 x 50	1 x 35	640,00 ₺
YE1 17050	1 x 70	1 x 50	640,00 ₺
YE1 19570	1 x 95	1 x 70	750,00 ₺
YE1 112095	1 x 120	1 x 95	750,00 ₺
YE1 41515	4 x 1,5	4 x 1,5	830,00 ₺
YE1 42515	4 x 2,5	4 x 1,5	830,00 ₺
YE1 44015	4 x 4	4 x 1,5	830,00 ₺
YE1 41015	4 x 10	4 x 1,5	830,00 ₺



ŞEFFAF REÇİNELİ KABLO EK MUFLARI

TRANSPARENT RESIN CABLE JOINTS

KOD CODE	KABLO KESİTİ CROSS SECTION	KOLİ ADETİ UNIT / BOX	FİYAT PRICE
TE1 410	4X10	10	1.670,00 ₺
TE1 416	4x16	10	1.670,00 ₺
TE1 425	4x25	10	1.745,00 ₺
TE1 31610	3x16+10	10	1.670,00 ₺
TE1 32516	3x25+16	10	1.745,00 ₺
TE1 516	5x16	10	1.780,00 ₺

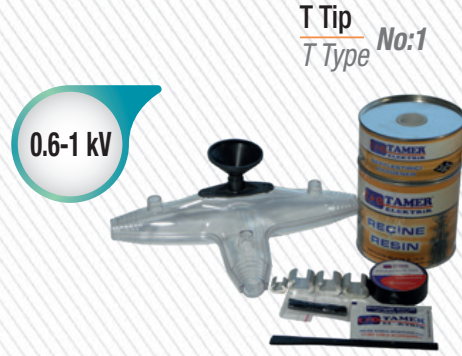

KOD CODE	KABLO KESİTİ CROSS SECTION	KOLİ ADETİ UNIT / BOX	FİYAT PRICE
TE1 435	4 x 35	10	2.650,00 ₺
TE1 450	4 x 50	10	2.675,00 ₺
TE1 470	4 x 70	10	2.700,00 ₺
TE1 33516	3 x 35 + 16	10	2.635,00 ₺
TE1 35025	3 x 50 + 25	10	2.665,00 ₺
TE1 37035	3 x 70 + 35	10	2.690,00 ₺

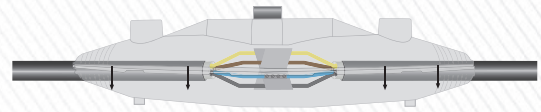

KOD CODE	KABLO KESİTİ CROSS SECTION	ADET/KOLİ UNIT/BOX	FİYAT PRICE
TE1 495	4 x 95	10	4.045,00 ₺
TE1 4120	4 x 120	1	4.115,00 ₺
TE1 4150	4 x 150	1	4.165,00 ₺
TE1 4185	4 x 185	1	4.215,00 ₺
TE1 4240	4 x 240	1	4.265,00 ₺
TE1 39550	3 x 95 + 50	10	3.990,00 ₺
TE1 31207	3 x 120 + 70	1	4.070,00 ₺
TE1 31507	3 x 150 + 70	1	4.115,00 ₺
TE1 31859	3 x 185 + 95	1	4.165,00 ₺
TE1 32401	3 x 240 + 120	1	4.215,00 ₺

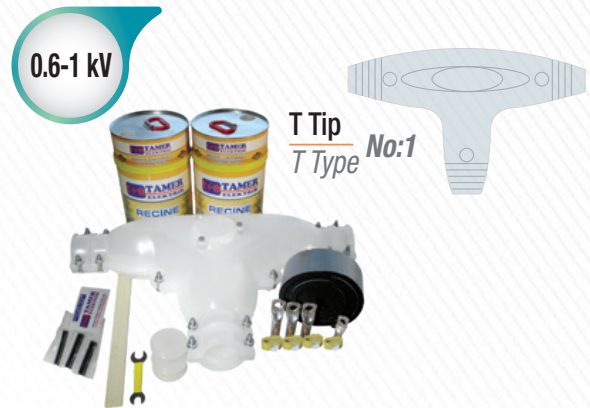



0.6-1 kV

KOD CODE	KABLO KESİTİ CROSS SECTION	FİYAT PRICE
VDE1 410	4X10	1.025,00 ₺
VDE1 416	4x16	1.025,00 ₺
VDE1 425	4x25	1.070,00 ₺
VDE1 31610	3x16+10	1.025,00 ₺
VDE1 32516	3x25+16	1.070,00 ₺



0.6-1 kV

KOD CODE	KABLO KESİTİ CROSS SECTION	FİYAT PRICE
VDEX1 410	4X10	730,00 ₺
VDEX1 416	4x16	730,00 ₺
VDEX1 425	4x25	765,00 ₺
VDEX1 31610	3x16+10	730,00 ₺
VDEX1 32516	3x25+16	765,00 ₺



0.6-1 kV

KOD CODE	KABLO KESİTİ CROSS SECTION	FİYAT PRICE
VDE1 435	4x35	1.730,00 ₺
VDE1 450	4x50	1.730,00 ₺
VDE1 470	4x70	1.800,00 ₺
VDE1 33516	3x35+16	1.730,00 ₺
VDE1 35025	3x50+25	1.730,00 ₺
VDE1 37035	3 x 70 + 35	1.800,00 ₺



0.6-1 kV

KOD CODE	KABLO KESİTİ CROSS SECTION	FİYAT PRICE
VDEX1 435	4x35	1.220,00 ₺
VDEX1 450	4x50	1.220,00 ₺
VDEX1 470	4x70	1.250,00 ₺
VDEX1 33516	3x35+16	1.220,00 ₺
VDEX1 35025	3x50+25	1.220,00 ₺
VDEX1 37035	3 x 70 + 35	1.250,00 ₺



0.6-1 kV

KOD CODE	KABLO KESİTİ CROSS SECTION	FİYAT PRICE
VDE1 495	4 x 95	2.195,00 ₺
VDE1 4120	4 x 120	2.775,00 ₺
VDE1 4150	4 x 150	3.115,00 ₺
VDE1 4185	4 x 185	3.115,00 ₺
VDE1 4240	4 x 240	3.115,00 ₺
VDE1 39550	3 x 95 + 50	2.195,00 ₺
VDE1 31207	3 x 120 + 70	2.315,00 ₺
VDE1 31507	3 x 150 + 70	3.115,00 ₺
VDE1 31859	3 x 185 + 95	3.115,00 ₺
VDE1 32401	3 x 240 + 120	3.115,00 ₺



0.6-1 kV

KOD CODE	KABLO KESİTİ CROSS SECTION	FİYAT PRICE
VDEX1 495	4 x 95	1.460,00 ₺
VDEX1 4120	4 x 120	1.990,00 ₺
VDEX1 4150	4 x 150	1.990,00 ₺
VDEX1 4185	4 x 185	1.990,00 ₺
VDEX1 4240	4 x 240	1.990,00 ₺
VDEX1 39550	3 x 95 + 50	1.460,00 ₺
VDEX1 31207	3 x 120 + 70	1.990,00 ₺
VDEX1 31507	3 x 150 + 70	1.990,00 ₺
VDEX1 31859	3 x 185 + 95	1.990,00 ₺
VDEX1 32401	3 x 240 + 120	1.990,00 ₺

Y BRANŞMAN VIDALI ŞEFFAF REÇİNELİ KABLO EK MUFLARI

Y TYPE SCREW TRANSPARENT RESIN CABLE JOINTS



0.6-1 kV

KOD CODE	KABLO KESİTİ CROSS SECTION	FİYAT PRICE
VYE1 410	4X10	1.245,00 ₺
VYE1 416	4x16	1.245,00 ₺
VYE1 425	4x25	1.290,00 ₺
VYE1 31610	3x16+10	1.245,00 ₺
VYE1 32516	3x25+16	1.290,00 ₺



0.6-1 kV

KOD CODE	KABLO KESİTİ CROSS SECTION	FİYAT PRICE
VYEX1 410	4X10	1.125,00 ₺
VYEX1 416	4x16	1.125,00 ₺
VYEX1 425	4x25	1.175,00 ₺
VYEX1 31610	3x16+10	1.125,00 ₺
VYEX1 32516	3x25+16	1.175,00 ₺



0.6-1 kV

KOD CODE	KABLO KESİTİ CROSS SECTION	FİYAT PRICE
VYE1 435	4x35	1.895,00 ₺
VYE1 450	4x50	1.895,00 ₺
VYE1 470	4x70	1.925,00 ₺
VYE1 33516	3x35+16	1.895,00 ₺
VYE1 35025	3x50+25	1.895,00 ₺
VYE1 37035	3 x 70 + 35	1.925,00 ₺

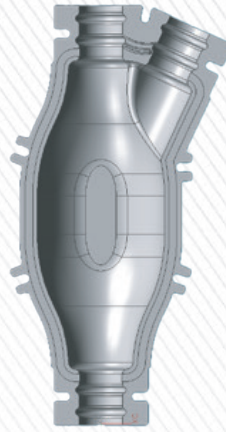

0.6-1 kV

KOD CODE	KABLO KESİTİ CROSS SECTION	FİYAT PRICE
VYEX1 435	4x35	1.725,00 ₺
VYEX1 450	4x50	1.725,00 ₺
VYEX1 470	4x70	1.775,00 ₺
VYEX1 33516	3x35+16	1.725,00 ₺
VYEX1 35025	3x50+25	1.725,00 ₺
VYEX1 37035	3 x 70 + 35	1.775,00 ₺



0.6-1 kV

KOD CODE	KABLO KESİTİ CROSS SECTION	FİYAT PRICE
VYE1 495	4 x 95	2.700,00 ₺
VYE1 4120	4 x 120	2.760,00 ₺
VYE1 39550	3 x 95 + 50	2.700,00 ₺
VYE1 31207	3 x 120 + 70	2.760,00 ₺

0.6-1 kV

KOD CODE	KABLO KESİTİ CROSS SECTION	FİYAT PRICE
VYEX1 495	4 x 95	2.460,00 ₺
VYEX1 4120	4 x 120	2.520,00 ₺
VYEX1 39550	3 x 95 + 50	2.460,00 ₺
VYEX1 31207	3 x 120 + 70	2.520,00 ₺



0.6-1 kV

KOD CODE	KABLO KESİTİ CROSS SECTION	FİYAT PRICE
VYE1 4150	4 x 150	4.450,00 ₺
VYE1 4185	4 x 185	4.450,00 ₺
VYE1 4240	4 x 240	4.475,00 ₺
VYE1 31507	3 x 150 + 70	4.450,00 ₺
VYE1 31859	3 x 185 + 95	4.450,00 ₺
VYE1 32401	3 x 240 + 120	4.475,00 ₺

0.6-1 kV

KOD CODE	KABLO KESİTİ CROSS SECTION	FİYAT PRICE
VYEX1 4150	4 x 150	3.635,00 ₺
VYEX1 4185	4 x 185	3.635,00 ₺
VYEX1 4240	4 x 240	3.670,00 ₺
VYEX1 31507	3 x 150 + 70	3.635,00 ₺
VYEX1 31859	3 x 185 + 95	3.635,00 ₺
VYEX1 32401	3 x 240 + 120	3.670,00 ₺



3.5-6 kV



5.8-10 kV

KOD CODE	KABLO KESİTİ CROSS SECTION	FİYAT PRICE
E6 125	1x25+16	2.185,00 ₺
E6 135	1x35+16	2.185,00 ₺
E6 150	1x50+16	2.185,00 ₺
E6 170	1x70+16	2.185,00 ₺
E6 195	1x95+16	2.185,00 ₺
E6 1120	1x120+16	2.310,00 ₺
E6 1150	1x150+25	2.310,00 ₺
E6 1185	1x185+25	2.345,00 ₺
E6 1240	1x240+25	2.345,00 ₺
E6 1300	1x300+25	2.555,00 ₺

KOD CODE	KABLO KESİTİ CROSS SECTION	FİYAT PRICE
E10 125	1x25+16	2.185,00 ₺
E10 135	1x35+16	2.185,00 ₺
E10 150	1x50+16	2.185,00 ₺
E10 170	1x70+16	2.185,00 ₺
E10 195	1x95+16	2.185,00 ₺
E10 1120	1x120+16	2.310,00 ₺
E10 1150	1x150+25	2.310,00 ₺
E10 1185	1x185+25	2.345,00 ₺
E10 1240	1x240+25	2.345,00 ₺
E10 1300	1x300+25	2.555,00 ₺

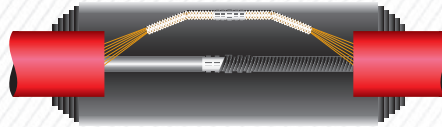

8.7-15 kV



20.8-36 kV

KOD CODE	KABLO KESİTİ CROSS SECTION	FİYAT PRICE
E15 125	1x25+16	2.185,00 ₺
E15 135	1x35+16	2.185,00 ₺
E15 150	1x50+16	2.185,00 ₺
E15 170	1x70+16	2.185,00 ₺
E15 195	1x95+16	2.185,00 ₺
E15 1120	1x120+16	2.310,00 ₺
E15 1150	1x150+25	2.310,00 ₺
E15 1185	1x185+25	2.345,00 ₺
E15 1240	1x240+25	2.345,00 ₺
E15 1300	1x300+25	2.555,00 ₺

KOD CODE	KABLO KESİTİ CROSS SECTION	FİYAT PRICE
E36 125	1x25+16	3.750,00 ₺
E36 135	1x35+16	3.750,00 ₺
E36 150	1x50+16	3.750,00 ₺
E36 170	1x70+16	3.750,00 ₺
E36 195	1x95+16	3.750,00 ₺
E36 1120	1x120+16	3.900,00 ₺
E36 1150	1x150+25	3.900,00 ₺
E36 1185	1x185+25	3.955,00 ₺
E36 1240	1x240+25	3.955,00 ₺
E36 1300	1x300+25	3.955,00 ₺

O.G. ÜÇ DAMARLI REÇİNELİ KABLO EK MUFLARI

M.V. THREE CORES RESIN CABLE JOINTS

Reçineli
Ek Muflar



3.5-6 KV



5.8-10 KV

KOD CODE	KABLO KESİTİ CROSS SECTION	FİYAT PRICE
E6 325	3x25+16	7.645,00 ₺
E6 335	3x35+16	7.645,00 ₺
E6 350	3x50+16	7.645,00 ₺
E6 370	3x70+16	8.025,00 ₺
E6 395	3x95+16	8.025,00 ₺
E6 3120	3x120+16	8.165,00 ₺
E6 3150	3x150+25	8.165,00 ₺
E6 3185	3x185+25	8.270,00 ₺
E6 3240	3x240+25	8.270,00 ₺
E6 3300	3x300+25	8.410,00 ₺

KOD CODE	KABLO KESİTİ CROSS SECTION	FİYAT PRICE
E10 325	3x25+16	7.645,00 ₺
E10 335	3x35+16	7.645,00 ₺
E10 350	3x50+16	7.645,00 ₺
E10 370	3x70+16	8.025,00 ₺
E10 395	3x95+16	8.025,00 ₺
E10 3120	3x120+16	8.165,00 ₺
E10 3150	3x150+25	8.165,00 ₺
E10 3185	3x185+25	8.270,00 ₺
E10 3240	3x240+25	8.270,00 ₺
E10 3300	3X300+25	8.410,00 ₺

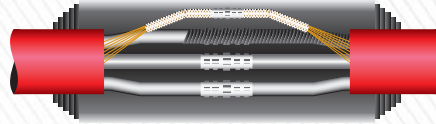

8.7-15 KV



20.8-36 KV

KOD CODE	KABLO KESİTİ CROSS SECTION	FİYAT PRICE
E15 325	3x25+16	7.645,00 ₺
E15 335	3x35+16	7.645,00 ₺
E15 350	3x50+16	7.645,00 ₺
E15 370	3x70+16	8.025,00 ₺
E15 395	3x95+16	8.025,00 ₺
E15 3120	3x120+16	8.165,00 ₺
E15 3150	3x150+25	8.165,00 ₺
E15 3185	3x185+25	8.270,00 ₺
E15 3240	3x240+25	8.270,00 ₺
E15 3300	3x300+25	8.410,00 ₺

KOD CODE	KABLO KESİTİ CROSS SECTION	FİYAT PRICE
E36 335	3x35+16	17.000,00 ₺
E36 350	3x50+16	17.000,00 ₺
E36 370	3x70+16	17.250,00 ₺
E36 395	3x95+16	17.250,00 ₺
E36 3120	3x120+16	17.500,00 ₺
E36 3150	3x150+25	17.500,00 ₺
E36 3185	3x185+25	17.800,00 ₺
E36 3240	3x240+25	17.800,00 ₺
E36 3300	3x300+25	18.000,00 ₺



0.6-1 kV

KOD CODE	KABLO KESİTİ CROSS SECTION	FİYAT PRICE
PSİLDE1 410	4x10	1.310,00 ₺
PSİLDE1 416	4x16	1.310,00 ₺
PSİLDE1 425	4x25	1.430,00 ₺
PSİLDE1 31610	3x16+10	1.310,00 ₺
PSİLDE1 32516	3x25+16	1.430,00 ₺



0.6-1 kV

KOD CODE	KABLO KESİTİ CROSS SECTION	FİYAT PRICE
PSİLDEX1 410	4x10	1.080,00 ₺
PSİLDEX1 416	4x16	1.080,00 ₺
PSİLDEX1 425	4x25	1.080,00 ₺
PSİLDEX1 31610	3x16+10	1.080,00 ₺
PSİLDEX1 32516	3x25+16	1.080,00 ₺



0.6-1 kV

KOD CODE	KABLO KESİTİ CROSS SECTION	FİYAT PRICE
PSİLDE1 435	4x35	2.090,00 ₺
PSİLDE1 450	4x50	2.090,00 ₺
PSİLDE1 470	4x70	2.090,00 ₺
PSİLDE1 33516	3x35+16	2.085,00 ₺
PSİLDE1 35025	3x50+25	2.085,00 ₺
PSİLDE1 37035	3 x 70 + 35	2.085,00 ₺

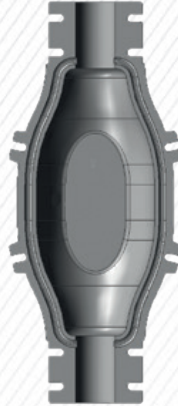

0.6-1 kV

KOD CODE	KABLO KESİTİ CROSS SECTION	FİYAT PRICE
PSİLDEX1 435	4x35	1.750,00 ₺
PSİLDEX1 450	4x50	1.750,00 ₺
PSİLDEX1 470	4x70	1.750,00 ₺
PSİLDEX1 33516	3x35+16	1.750,00 ₺
PSİLDEX1 35025	3x50+25	1.750,00 ₺
PSİLDEX1 37035	3 x 70 + 35	1.750,00 ₺



0.6-1 kV

KOD CODE	KABLO KESİTİ CROSS SECTION	FİYAT PRICE
PSİLDE1 495	4 x 95	2.560,00 ₺
PSİLDE1 4120	4 x 120	2.710,00 ₺
PSİLDE1 4150	4 x 150	3.215,00 ₺
PSİLDE1 4185	4 x 185	3.600,00 ₺
PSİLDE1 4240	4 x 240	3.815,00 ₺
PSİLDE1 39550	3 x 95 + 50	2.550,00 ₺
PSİLDE1 31207	3 x 120 + 70	2.705,00 ₺
PSİLDE1 31507	3 x 150 + 70	3.210,00 ₺
PSİLDE1 31859	3 x 185 + 95	3.590,00 ₺
PSİLDE1 32401	3 x 240 + 120	3.810,00 ₺



0.6-1 kV

KOD CODE	KABLO KESİTİ CROSS SECTION	FİYAT PRICE
PSİLDEX1 495	4 x 95	2.065,00 ₺
PSİLDEX1 4120	4 x 120	2.240,00 ₺
PSİLDEX1 4150	4 x 150	2.690,00 ₺
PSİLDEX1 4185	4 x 185	2.930,00 ₺
PSİLDEX1 4240	4 x 240	3.370,00 ₺
PSİLDEX1 39550	3 x 95 + 50	2.055,00 ₺
PSİLDEX1 31207	3 x 120 + 70	2.235,00 ₺
PSİLDEX1 31507	3 x 150 + 70	2.690,00 ₺
PSİLDEX1 31859	3 x 185 + 95	2.915,00 ₺
PSİLDEX1 32401	3 x 240 + 120	3.360,00 ₺

YENİLENEBİLİR Y BRANŞMAN VİDALI ŞEFFAF KABLO EK MUFLARI

RENEWABLE Y TYPE SCREW TRANSPARENT CABLE JOINTS



0.6-1 kV

KOD CODE	KABLO KESİTİ CROSS SECTION	FİYAT PRICE
PSİLYE1 410	4X10	1.895,00 ₺
PSİLYE1 416	4x16	1.895,00 ₺
PSİLYE1 425	4x25	2.005,00 ₺
PSİLYE1 31610	3x16+10	1.895,00 ₺
PSİLYE1 32516	3x25+16	2.005,00 ₺



0.6-1 kV

KOD CODE	KABLO KESİTİ CROSS SECTION	FİYAT PRICE
PSİLYEX1 410	4x10	1.560,00 ₺
PSİLYEX1 416	4x16	1.560,00 ₺
PSİLYEX1 425	4x25	1.560,00 ₺
PSİLYEX1 31610	3x16+10	1.560,00 ₺
PSİLYEX1 32516	3x25+16	1.560,00 ₺



0.6-1 kV

KOD CODE	KABLO KESİTİ CROSS SECTION	FİYAT PRICE
PSİLYE1 435	4x35	2.820,00 ₺
PSİLYE1 450	4x50	2.820,00 ₺
PSİLYE1 470	4 x 70	2.845,00 ₺
PSİLYE1 33516	3x35+16	2.820,00 ₺
PSİLYE1 35025	3x50+25	2.820,00 ₺
PSİLYE1 37035	3 x 70 + 35	2.845,00 ₺



0.6-1 kV

KOD CODE	KABLO KESİTİ CROSS SECTION	FİYAT PRICE
PSİLYEX1 435	4x35	2.270,00 ₺
PSİLYEX1 450	4x50	2.270,00 ₺
PSİLYEX1 470	4x70	2.270,00 ₺
PSİLYEX1 33516	3x35+16	2.270,00 ₺
PSİLYEX1 35025	3x50+25	2.270,00 ₺
PSİLYEX1 37035	3 x 70 + 35	2.270,00 ₺

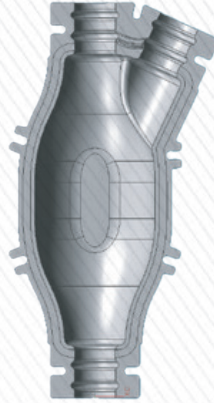

0.6-1 kV

KOD CODE	KABLO KESİTİ CROSS SECTION	FİYAT PRICE
PSİLYE1 495	4 x 95	3.865,00 ₺
PSİLYE1 4120	4 x 120	3.900,00 ₺
PSİLYE1 39550	3 x 95 + 50	3.865,00 ₺
PSİLYE1 31207	3 x 120 + 70	3.900,00 ₺



0.6-1 kV

KOD CODE	KABLO KESİTİ CROSS SECTION	FİYAT PRICE
PSİLYEX1 495	4 x 95	3.170,00 ₺
PSİLYEX1 4120	4 x 120	3.170,00 ₺
PSİLYEX1 39550	3 x 95 + 50	3.170,00 ₺
PSİLYEX1 31207	3 x 120 + 70	3.170,00 ₺



0.6-1 kV

KOD CODE	KABLO KESİTİ CROSS SECTION	FİYAT PRICE
PSİLYE1 4150	4 x 150	5.550,00 ₺
PSİLYE1 4185	4 x 185	5.550,00 ₺
PSİLYE1 4240	4 x 240	5.550,00 ₺
PSİLYE1 31507	3 x 150 + 70	5.580,00 ₺
PSİLYE1 31859	3 x 185 + 95	5.580,00 ₺
PSİLYE1 32401	3 x 240 + 120	5.580,00 ₺



0.6-1 kV

KOD CODE	KABLO KESİTİ CROSS SECTION	FİYAT PRICE
PSİLYEX1 4150	4 x 150	4.645,00 ₺
PSİLYEX1 4185	4 x 185	4.645,00 ₺
PSİLYEX1 4240	4 x 240	4.645,00 ₺
PSİLYEX1 31507	3 x 150 + 70	4.645,00 ₺
PSİLYEX1 31859	3 x 185 + 95	4.645,00 ₺
PSİLYEX1 32401	3 x 240 + 120	4.645,00 ₺

0.6-1 kV

KOD CODE	KABLO KESİTİ CROSS SECTION	FİYAT PRICE
PSİLTE1 4120	4 x 120	5.550,00 ₺
PSİLTE1 4150	4 x 150	5.550,00 ₺
PSİLTE1 4185	4 x 185	5.550,00 ₺
PSİLTE1 4240	4 x 240	5.550,00 ₺
PSİLTE1 31207	3 x 120 + 70	5.580,00 ₺
PSİLTE1 31507	3 x 150 + 70	5.580,00 ₺
PSİLTE1 31859	3 x 185 + 95	5.580,00 ₺
PSİLTE1 32401	3 x 240 + 120	5.580,00 ₺



YENİLENEBİLİR ESNEK DOLGULU REÇİNELER

RENEWABLE FLEXIBLE RESINS FILLED



500 G



2 KG

KOD CODE	AĞIRLIK WEIGHT	ADET/KOLİ UNIT/BOX	FİYAT PRICE
PSİL 500	500 G	45	290,00 ₺

KOD CODE	AĞIRLIK WEIGHT	ADET/KOLİ UNIT/BOX	FİYAT PRICE
PSİL 2000	2KG	16	850,00 ₺



1 KG



3 KG

KOD CODE	AĞIRLIK WEIGHT	ADET/KOLİ UNIT/BOX	FİYAT PRICE
PSİL 1000	1KG	24	490,00 ₺

KOD CODE	AĞIRLIK WEIGHT	ADET/KOLİ UNIT/BOX	FİYAT PRICE
PSİL 3000	3KG	6	1.400,00 ₺



1.5 KG



4 KG

KOD CODE	AĞIRLIK WEIGHT	ADET/KOLİ UNIT/BOX	FİYAT PRICE
PSİL 1500	1,5KG	16	725,00 ₺

KOD CODE	AĞIRLIK WEIGHT	ADET/KOLİ UNIT/BOX	FİYAT PRICE
PSİL 4000	4KG	6	1.500,00 ₺

20 KG



KOD CODE	AĞIRLIK WEIGHT	ADET/KOLİ UNIT/BOX	FİYAT PRICE
PSİL 20000	20KG	1	7.350,00 ₺



210 G

KOD CODE	AĞIRLIK WEIGHT	ADET/KOLİ UNIT/BOX	FİYAT PRICE
PRO 210	210 G	100	135,00 ₺



300 G

KOD CODE	AĞIRLIK WEIGHT	ADET/KOLİ UNIT/BOX	FİYAT PRICE
PRO 300	300 G	72	160,00 ₺



500 G

KOD CODE	AĞIRLIK WEIGHT	ADET/KOLİ UNIT/BOX	FİYAT PRICE
PRO 500	500 G	45	220,00 ₺



600 G

KOD CODE	AĞIRLIK WEIGHT	ADET/KOLİ UNIT/BOX	FİYAT PRICE
PRO 600	600 G	45	280,00 ₺



1 KG

KOD CODE	AĞIRLIK WEIGHT	ADET/KOLİ UNIT/BOX	FİYAT PRICE
PRO 1000	1KG	24	395,00 ₺



1.5 KG

KOD CODE	AĞIRLIK WEIGHT	ADET/KOLİ UNIT/BOX	FİYAT PRICE
PRO 1500	1,5KG	16	590,00 ₺



2 KG

KOD CODE	AĞIRLIK WEIGHT	ADET/KOLİ UNIT/BOX	FİYAT PRICE
PRO 2000	2KG	16	770,00 ₺



3 KG

KOD CODE	AĞIRLIK WEIGHT	ADET/KOLİ UNIT/BOX	FİYAT PRICE
PRO 3000	3KG	6	1.170,00 ₺



4 KG

KOD CODE	AĞIRLIK WEIGHT	ADET/KOLİ UNIT/BOX	FİYAT PRICE
PRO 4000	4KG	6	1.370,00 ₺



20 KG

KOD CODE	AĞIRLIK WEIGHT	ADET/KOLİ UNIT/BOX	FİYAT PRICE
PRO 20000	20KG	1	5.460,00 ₺

AG BUŞING KAPAMALAR

LV BUSHING COVER

0.6-1 kV

KOD CODE	UYGUN TRAFİO SUITABLE TRANSF.	AKIM-AMPER (A) CURRENT (A)	ADET/UNIT	FİYAT PRICE
TBK-01	1kV,1000-1600kVA	2000-3150A	1	205,00 ₺
TBK-05	1kV, 500-800kVA	1000-1250A	1	185,00 ₺
TBK-04	1kV, 200-400kVA	630A	1	165,00 ₺
TBK-06	1kV, 50-160kVA	250A	1	155,00 ₺
TBK-07	1kV,2000-2500kVA	3150-4000A	1	425,00 ₺



OG BUŞING KAPAMA

MV BUSHING COVER

36 kV

KOD CODE	UYGUN TRAFİO SUITABLE TRANSF.	AKIM-AMPER (A) CURRENT (A)	ADET/UNIT	FİYAT PRICE
TBK-02	36kV,10-1600kVA	250-3150A	1	245,00 ₺

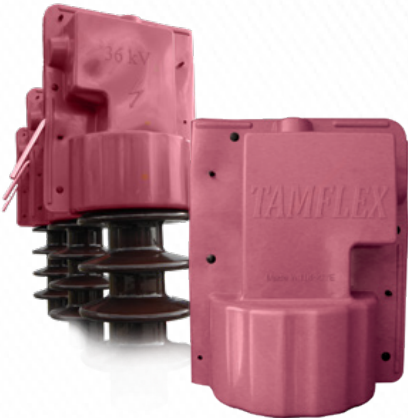

OG VHD İZOLATÖR KAPAMALAR
MV VHD INSULATOR COVER

36 kV

KOD CODE	UYGUN İZOLATÖR SUITABLE INSULATOR	ADET/UNIT	FİYAT PRICE
TBK-03 Ortadan Kollu Borulu	36kV, VHD-35 SII	1	350,00 ₺
TBKX-03 Ortadan Kollu Borusuz	36kV, VHD-35 SII	1	265,00 ₺
TBK-03-UB Uçlu Ortadan Kollu Borulu	36kV, VHD-35 SII	1	385,00 ₺
TBKX-03-U Uçlu Ortadan Kollu Borusuz	36kV, VHD-35 SII	1	295,00 ₺
TBK-03-YK Yandan Kollu	36kV, VHD-35 SII	1	350,00 ₺



OG GERĞİ KAPAMALAR
MV TENSIONER COVER

36 kV



TGK-02

TGK-01

KOD CODE	UYGUN İZOLATÖR SUITABLE INSULATOR.	ADET/ UNIT	FİYAT PRICE (m/₺)
TGK-01 OG Tekli Gerği İzolatör Kapama	36kV,K1-Porselen İzl.	1	425,00 ₺
TGK-02 OG Tekli Gerği Kapama	36kV,K1-Tekli Gerği	1	280,00 ₺

OG HAVAI HAT KAPAMALAR

MV OVERHEAD-LINE PROTECTION



36 kV



KOD CODE	İLETKEN TİPİ CONDUCTOR TYPE	MAKSİMUM İLETKEN ÇAPI MAX CONDUCTOR SIZE	METRE/ METER	FİYAT PRICE
THK-01	Swallow (3)-Tırnaklı Tip	16,50	1	105,00 ₺
	Raven(1/0)-Tırnaklı Tip			
	Piegon (3/0)-Tırnaklı Tip			
	Sparrow (2)-Tırnaklı Tip			
THK-01-F	Yanmazlık Özellikli/Flame Reterdant	16,50	1	205,00 ₺
THK-02	Hawk-477-Tırnaklı Tip	37	1	140,00 ₺
THK-02-F	Yanmazlık Özellikli/Flame Reterdant	37	1	285,00 ₺
THK-03	T Tipi Kapama Swallow (3), Raven(1/0), Sparrow (2)	16,50	Adet	215,00 ₺
THK-04	Swallow (3), Raven(1/0), Sparrow (2) -Borulu Tip	12	1	65,00 ₺
THK-05	Piegon (3/0)-Borulu Tip	17	1	80,00 ₺
THK-06	Swallow (3)-Tırnaklı Tip	13	1	105,00 ₺
THK-07	Hawk-477-Borulu Tip	29	1	130,00 ₺

OG PARAFUDR KAPAMA

MV SURGE ARRESTER COVER

36 kV

KOD CODE	UYGUN TRAFO SUITABLE TRANSF.	Akım-Amper (A) CURRENT (A)	ADET/ UNIT	FİYAT PRICE (m/₺)
TPK-01	36kV,10-1600kVA	250-3150A	1	125,00 ₺





0.6-1 kV



0.6-1 kV

KOD CODE	KABLO KESİTİ CROSS SECTION	FİYAT PRICE
S1 4105	4x1,5	190,00 ₺
S1 4205	4x2,5	190,00 ₺
S1 404	4x4	190,00 ₺
S1 406	4x6	190,00 ₺
S1 410	4x10	230,00 ₺
S1 416	4x16	300,00 ₺
S1 425	4x25	370,00 ₺
S1 435	4x35	420,00 ₺
S1 450	4x50	450,00 ₺
S1 470	4x70	680,00 ₺
S1 495	4x95	800,00 ₺
S1 4120	4x120	990,00 ₺
S1 4150	4x150	1.250,00 ₺
S1 4185	4x185	1.500,00 ₺
S1 4240	4x240	1.800,00 ₺
S1 4300	4x300	2.100,00 ₺
S1 4400	4x400	2.400,00 ₺
S1 31610	3x16+10	290,00 ₺
S1 32516	3x25+16	360,00 ₺
S1 33516	3x35+16	410,00 ₺
S1 35025	3x50+25	440,00 ₺
S1 37035	3x70+35	670,00 ₺
S1 39550	3x95+50	790,00 ₺
S1 31207	3x120+70	970,00 ₺
S1 31507	3x150+70	1.230,00 ₺
S1 31859	3x185+95	1.480,00 ₺
S1 32401	3x240+120	1.780,00 ₺
S1 33001	3x300+150	2.070,00 ₺
S1 34001	3x400+185	2.370,00 ₺

KOD CODE	KABLO KESİTİ CROSS SECTION	FİYAT PRICE
S1 315	3x1,5	175,00 ₺
S1 304	3x4	175,00 ₺
S1 306	3x6	175,00 ₺
S1 310	3x10	215,00 ₺
S1 316	3x16	285,00 ₺
S1 325	3x25	355,00 ₺
S1 335	3x35	400,00 ₺
S1 350	3x50	430,00 ₺
S1 370	3x70	645,00 ₺
S1 395	3x95	750,00 ₺
S1 3120	3x120	940,00 ₺
S1 3150	3x150	1.150,00 ₺
S1 3185	3x185	1.350,00 ₺
S1 3240	3x240	1.650,00 ₺
S1 3300	3x300	1.950,00 ₺
S1 3400	3x400	2.250,00 ₺

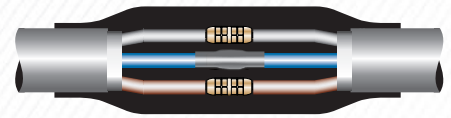

* İstenilen kablo kesitlerine göre ek yapılır. / * Produce joint according to demand

BAKIR İLETKENLER İÇİN ISI BÜZÜŞMELİ KABLO EK MUFLARI

FOR COPPER CONNECTORS HEAT SHRINKABLE CABLE JOINTS



0.6-1 kV

0.6-1 kV



KOD CODE	KABLO KESİTİ CROSS SECTION	FİYAT PRICE
S1 5105 - S1 5205	5x1,5 - 5x2,5	230,00 ₺
S1 504 - S1 506	5x4 - 5x6	230,00 ₺
S1 510 - S1 516	5x10 - 5x16	330,00 ₺
S1 525	5x25	465,00 ₺
S1 535	5x35	510,00 ₺
S1 550	5x50	550,00 ₺
S1 570	5x70	800,00 ₺
S1 595	5x95	960,00 ₺
S1 5120	5x120	1.150,00 ₺
S1 5150	5x150	1.650,00 ₺
S1 5185	5x185	1.750,00 ₺
S1 5240	5x240	2.150,00 ₺
S1 715 - S1 725	7x1,5 - 7x2,5	220,00 ₺
S1 1015 - S1 1025	10x1,5 - 10 x 2,5	320,00 ₺
S1 1215 - S1 1225	12x1,5 - 12x2,5	420,00 ₺

KOD CODE	KABLO KESİTİ CROSS SECTION	FİYAT PRICE
S1 215 - S1 204	2 x 1,5 - 2 x 4	160,00 ₺
S1 206 - S1 210	2 x 6 - 2 x 10	160,00 ₺
S1 216 - S1 225	2 x 16 - 2 x 25	220,00 ₺
S1 235 - S1 250	2 x 35 - 2 x 50	350,00 ₺
S1 270 - S1 295	2 x 70 - 2 x 95	600,00 ₺
S1 2120 - S1 2150	2 x 120 - 2 x 150	690,00 ₺
S1 2185	2 x 185	850,00 ₺
S1 2240	2 x 240	1.000,00 ₺
S1 2300	2 x 300	1.200,00 ₺
S1 2400	2 x 400	1.350,00 ₺

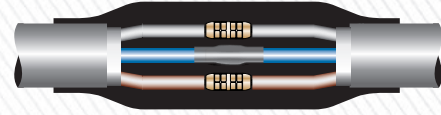

0.6-1 kV

KOD CODE	KABLO KESİTİ CROSS SECTION	FİYAT PRICE
S1 115 - S1 104	1x1,5 - 1x4	135,00 ₺
S1 106 - S1 110	1x6 - 1x10	135,00 ₺
S1 116 - S1 125	1x16 - 1x25	185,00 ₺
S1 135 - S1 150	1x35 - 1x50	285,00 ₺
S1 170 - S1 195	1x70 - 1x95	490,00 ₺
S1 1120 - S1 1150	1x120 - 1x150	570,00 ₺
S1 1185 - S1 1240	1x185 - 1x240	750,00 ₺
S1 1300 - S1 1400	1x300 - 1x400	900,00 ₺



0.6-1 kV



0.6-1 kV

KOD CODE	KABLO KESİTİ CROSS SECTION	FİYAT PRICE
DS1 4105	4x1,5	220,00 ₺
DS1 4205	4x2,5	220,00 ₺
DS1 404	4x4	220,00 ₺
DS1 406	4x6	220,00 ₺
DS1 410	4x10	260,00 ₺
DS1 416	4x16	340,00 ₺
DS1 425	4x25	410,00 ₺
DS1 435	4x35	500,00 ₺
DS1 450	4x50	550,00 ₺
DS1 470	4x70	770,00 ₺
DS1 495	4x95	950,00 ₺
DS1 4120	4x120	1.100,00 ₺
DS1 4150	4x150	1.580,00 ₺
DS1 4185	4x185	1.800,00 ₺
DS1 4240	4x240	2.300,00 ₺
DS1 4300	4x300	2.700,00 ₺
DS1 31610	3x16+10	330,00 ₺
DS1 32516	3x25+16	400,00 ₺
DS1 33516	3x35+16	490,00 ₺
DS1 35025	3x50+25	540,00 ₺
DS1 37035	3x70+35	760,00 ₺
DS1 39550	3x95+50	940,00 ₺
DS1 31207	3x120+70	1.080,00 ₺
DS1 31507	3x150+70	1.560,00 ₺
DS1 31859	3x185+95	1.780,00 ₺
DS1 32401	3x240+120	2.280,00 ₺
DS1 33001	3x300+150	2.680,00 ₺

KOD CODE	KABLO KESİTİ CROSS SECTION	FİYAT PRICE
DS1 315	3x1,5	195,00 ₺
DS1 304	3x4	195,00 ₺
DS1 306	3x6	195,00 ₺
DS1 310	3x10	240,00 ₺
DS1 316	3x16	320,00 ₺
DS1 325	3x25	390,00 ₺
DS1 335	3x35	470,00 ₺
DS1 350	3x50	530,00 ₺
DS1 370	3x70	735,00 ₺
DS1 395	3x95	900,00 ₺
DS1 3120	3x120	1.050,00 ₺
DS1 3150	3x150	1.430,00 ₺
DS1 3185	3x185	1.650,00 ₺
DS1 3240	3x240	2.150,00 ₺
DS1 3300	3x300	2.550,00 ₺

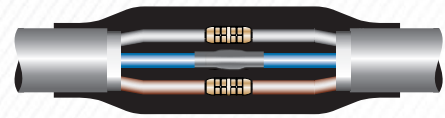

* İstenilen kablo kesitlerine göre ek yapılır. / * Produce joint according to demand

DIN BAKIR İLETKENLER İÇİN ISI BÜZÜŞMELİ KABLO EK MUFLARI

FOR DIN COPPER CONNECTORS HEAT SHRINKABLE CABLE JOINTS



0.6-1 kV



0.6-1 kV

KOD CODE	KABLO KESİTİ CROSS SECTION	FİYAT PRICE
DS1 5105 - DS1 5205	5x1,5 - 5x2,5	275,00 ₺
DS1 504 - DS1 506	5x4 - 5x6	275,00 ₺
DS1 510 - DS1 516	5x10 - 5x16	395,00 ₺
DS1 525	5x25	555,00 ₺
DS1 535	5x35	610,00 ₺
DS1 550	5x50	660,00 ₺
DS1 570	5x70	960,00 ₺
DS1 595	5x95	1.150,00 ₺
DS1 5120	5x120	1.380,00 ₺
DS1 5150	5x150	1.980,00 ₺
DS1 5185	5x185	2.100,00 ₺
DS1 5240	5x240	2.580,00 ₺
DS1 715 - DS1 725	7x1,5 - 7x2,5	265,00 ₺
DS1 1015 - DS1 1025	10x1,5 - 10 x 2,5	385,00 ₺
DS1 1215 - S1 1225	12x1,5 - 12x2,5	500,00 ₺

KOD CODE	KABLO KESİTİ CROSS SECTION	FİYAT PRICE
DS1 215 - DS1 204	2 x 1,5 - 2 x 4	190,00 ₺
DS1 206 - DS1 210	2 x 6 - 2 x 10	190,00 ₺
DS1 216 - DS1 225	2 x 16 - 2 x 25	260,00 ₺
DS1 235 - DS1 250	2 x 35 - 2 x 50	420,00 ₺
DS1 270 - DS1 295	2 x 70 - 2 x 95	720,00 ₺
DS1 2120 - DS1 2150	2 x 120 - 2 x 150	830,00 ₺
DS1 2185	2 x 185	1.040,00 ₺
DS1 2240	2 x 240	1.200,00 ₺
DS1 2300	2 x 300	1.400,00 ₺

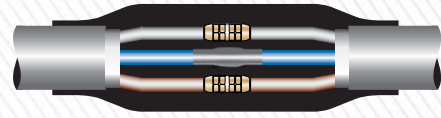

0.6-1 kV

KOD CODE	KABLO KESİTİ CROSS SECTION	FİYAT PRICE
DS1 115 - DS1 104	1x1,5 - 1x4	165,00 ₺
DS1 106 - DS1 110	1x6 - 1x10	165,00 ₺
DS1 116 - DS1 125	1x16 - 1x25	220,00 ₺
DS1 135 - DS1 150	1x35 - 1x50	340,00 ₺
DS1 170 - DS1 195	1x70 - 1x95	585,00 ₺
DS1 1120 - DS1 1150	1x120 - 1x150	680,00 ₺
DS1 1185 - DS1 1240	1x185 - 1x240	900,00 ₺
DS1 1300	1x300	1.080,00 ₺



0.6-1 kV

KOD CODE	KABLO KESİTİ CROSS SECTION	FİYAT PRICE
AS1 410	4x10	220,00 ₺
AS1 416	4x16	290,00 ₺
AS1 425	4x25	380,00 ₺
AS1 435	4x35	410,00 ₺
AS1 450	4x50	440,00 ₺
AS1 470	4x70	670,00 ₺
AS1 495	4x95	790,00 ₺
AS1 4120	4x120	970,00 ₺
AS1 4150	4x150	1.230,00 ₺
AS1 4185	4x185	1.480,00 ₺
AS1 4240	4x240	1.780,00 ₺
AS1 4300	4x300	2.080,00 ₺
AS1 4400	4x400	2.380,00 ₺
AS1 31610	3x16+10	280,00 ₺
AS1 32516	3x25+16	350,00 ₺
AS1 33516	3x35+16	400,00 ₺
AS1 35025	3x50+25	430,00 ₺
AS1 37035	3x70+35	660,00 ₺
AS1 39550	3x95+50	780,00 ₺
AS1 31207	3x120+70	950,00 ₺
AS1 31507	3x150+70	1.210,00 ₺
AS1 31859	3x185+95	1.460,00 ₺
AS1 32401	3x240+120	1.760,00 ₺
AS1 33001	3x300+150	2.050,00 ₺
AS1 34001	3x400+185	2.350,00 ₺

0.6-1 kV



KOD CODE	KABLO KESİTİ CROSS SECTION	FİYAT PRICE
AS1 310	3x10	200,00 ₺
AS1 316	3x16	275,00 ₺
AS1 325	3x25	345,00 ₺
AS1 335	3x35	390,00 ₺
AS1 350	3x50	420,00 ₺
AS1 370	3x70	635,00 ₺
AS1 395	3x95	740,00 ₺
AS1 3120	3x120	920,00 ₺
AS1 3150	3x150	1.160,00 ₺
AS1 3185	3x185	1.330,00 ₺
AS1 3240	3x240	1.630,00 ₺
AS1 3300	3x300	1.930,00 ₺
AS1 3400	3x400	2.230,00 ₺

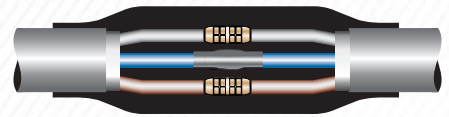

ALÜMİNYUM İLETKENLER İÇİN ISI BÜZÜŞMELİ KABLO EK MUFLARI

FOR ALUMINUM CONNECTORS HEAT SHRINKABLE CABLE JOINTS

KOD CODE	KABLO KESİTİ CROSS SECTION	FİYAT PRICE
AS1 510 - S1 516	5x10 - 5x16	320,00 ₺
AS1 525	5x25	455,00 ₺
AS1 535	5x35	500,00 ₺
AS1 550	5x50	540,00 ₺
AS1 570	5x70	790,00 ₺
AS1 595	5x95	950,00 ₺
AS1 5120	5x120	1.130,00 ₺
AS1 5150	5x150	1.630,00 ₺
AS1 5185	5x185	1.730,00 ₺
AS1 5240	5x240	2.130,00 ₺

0.6-1 kV

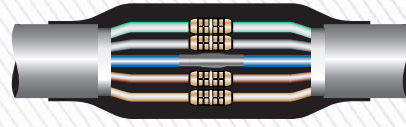

KOD CODE	KABLO KESİTİ CROSS SECTION	FİYAT PRICE
AS1 216	2x16	210,00 ₺
AS1 225	2 x 25	210,00 ₺
AS1 235 - AS1 250	2 x 35 - 2 x 50	340,00 ₺
AS1 270 - AS1 295	2 x 70 - 2 x 95	590,00 ₺
AS1 2120 - AS1 2150	2 x 120 - 2 x 150	670,00 ₺
AS1 2185	2 x 185	830,00 ₺
AS1 2240	2 x 240	980,00 ₺
AS1 2300	2 x 300	1.180,00 ₺
AS1 2400	2 x 400	1.330,00 ₺

0.6-1 kV



KOD CODE	KABLO KESİTİ CROSS SECTION	FİYAT PRICE
AS1 125	1 x 25	175,00 ₺
AS1 135 - AS1 150	1 x 35 - 1 x 50	275,00 ₺
AS1 170 - AS1 195	1 x 70 - 1 x 95	480,00 ₺
AS1 1120 - AS1 1150	1 x 120 - 1 x 150	550,00 ₺
AS1 1185 - AS1 1240	1 x 185 - 1 x 240	730,00 ₺
AS1 1300 - AS1 1400	1 x 300 - 1 x 400	880,00 ₺

0.6-1 kV



0.6-1 kV



KOD CODE	KABLO KESİTİ CROSS SECTION	FİYAT PRICE
FS1 31610	3x16+10	860,00 ₺
FS1 32516	3x25+16	915,00 ₺
FS1 33516	3x35+16	930,00 ₺
FS1 35025	3x50+25	955,00 ₺
FS1 37035	3x70+35	1.230,00 ₺
FS1 39550	3x95+50	1.270,00 ₺
FS1 31207	3x120+70	1.500,00 ₺
FS1 31507	3x150+70	1.550,00 ₺
FS1 31859	3x185+95	1.850,00 ₺
FS1 32401	3x240+120	2.040,00 ₺
FS1 33001	3x300+150	2.470,00 ₺
FS1 34001	3x400+185	2.740,00 ₺
FS1 4105	4x1,5	765,00 ₺
FS1 4205	4x2,5	765,00 ₺
FS1 404	4x4	765,00 ₺
FS1 406	4x6	765,00 ₺
FS1 410	4x10	820,00 ₺
FS1 416	4x16	870,00 ₺
FS1 425	4x25	925,00 ₺
FS1 435	4x35	940,00 ₺
FS1 450	4x50	965,00 ₺
FS1 470	4x70	1.240,00 ₺
FS1 495	4x95	1.280,00 ₺
FS1 4120	4x120	1.520,00 ₺
FS1 4150	4x150	1.580,00 ₺
FS1 4185	4x185	1.880,00 ₺
FS1 4240	4x240	2.070,00 ₺
FS1 4300	4x300	2.500,00 ₺
FS1 4400	4x400	2.780,00 ₺

KOD CODE	KABLO KESİTİ CROSS SECTION	FİYAT PRICE
FS1 5105-FS1 5205	5x1,5-5x2,5	810,00 ₺
FS1 504-FS1 506	5x4-5x6	810,00 ₺
FS1 510	5x10	870,00 ₺
FS1 516	5x16	925,00 ₺
FS1 525	5x25	990,00 ₺
FS1 535	5x35	1.030,00 ₺
FS1 550	5x50	1.100,00 ₺
FS1 570	5x70	1.375,00 ₺
FS1 595	5x95	1.560,00 ₺
FS1 5120	5x120	1.730,00 ₺
FS1 5150	5x150	1.800,00 ₺
FS1 5185	5x185	2.340,00 ₺
FS1 5240	5x240	2.580,00 ₺

KOD CODE	KABLO KESİTİ CROSS SECTION	FİYAT PRICE
FS1 135	1x35	815,00 ₺
FS1 150	1x50	815,00 ₺
FS1 170	1x70	875,00 ₺
FS1 195	1x95	875,00 ₺
FS1 1120	1x120	970,00 ₺
FS1 1150	1x150	970,00 ₺
FS1 1185	1x185	1.090,00 ₺
FS1 1240	1x240	1.090,00 ₺
FS1 1300	1x300	1.270,00 ₺

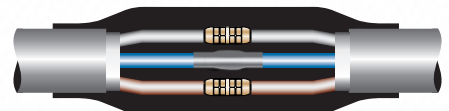

FERMUARLI ALÜMİNYUM ISI BÜZÜŞMELİ KABLO EK MUFLARI

REPAIR SLEEVE ALUMINUM HEAT SHRINKABLE CABLE JOINTS

0.6-1 kV



KOD CODE	KABLO KESİTİ CROSS SECTION	FİYAT PRICE
AFS1 31610	3x16+10	850,00 ₺
AFS1 32516	3x25+16	905,00 ₺
AFS1 33516	3x35+16	920,00 ₺
AFS1 35025	3x50+25	945,00 ₺
AFS1 37035	3x70+35	1.220,00 ₺
AFS1 39550	3x95+50	1.260,00 ₺
AFS1 31207	3x120+70	1.480,00 ₺
AFS1 31507	3x150+70	1.530,00 ₺
AFS1 31859	3x185+95	1.830,00 ₺
AFS1 32401	3x240+120	2.020,00 ₺
AFS1 33001	3x300+150	2.450,00 ₺
AFS1 34001	3x400+185	2.710,00 ₺
AFS1 4105	4x1,5	755,00 ₺
AFS1 4205	4x2,5	755,00 ₺
AFS1 404	4x4	755,00 ₺
AFS1 406	4x6	755,00 ₺
AFS1 410	4x10	810,00 ₺
AFS1 416	4x16	860,00 ₺
AFS1 425	4x25	915,00 ₺
AFS1 435	4x35	930,00 ₺
AFS1 450	4x50	955,00 ₺
AFS1 470	4x70	1.230,00 ₺
AFS1 495	4x95	1.270,00 ₺
AFS1 4120	4x120	1.500,00 ₺
AFS1 4150	4x150	1.560,00 ₺
AFS1 4185	4x185	1.860,00 ₺
AFS1 4240	4x240	2.050,00 ₺
AFS1 4300	4x300	2.480,00 ₺
AFS1 4400	4x400	2.750,00 ₺

KOD CODE	KABLO KESİTİ CROSS SECTION	FİYAT PRICE
AFS1 5105-AFS1 5205	5x1,5-5x2,5	800,00 ₺
AFS1 504-AFS1 506	5x4-5x6	800,00 ₺
AFS1 510	5x10	860,00 ₺
AFS1 516	5x16	915,00 ₺
AFS1 525	5x25	980,00 ₺
AFS1 535	5x35	1.020,00 ₺
AFS1 550	5x50	1.200,00 ₺
AFS1 570	5x70	1.320,00 ₺
AFS1 595	5x95	1.550,00 ₺
AFS1 5120	5x120	1.710,00 ₺
AFS1 5150	5x150	1.780,00 ₺
AFS1 5185	5x185	2.320,00 ₺
AFS1 5240	5x240	2.560,00 ₺

KOD CODE	KABLO KESİTİ CROSS SECTION	FİYAT PRICE
AFS1 135	1x35	805,00 ₺
AFS1 150	1x50	805,00 ₺
AFS1 170	1x70	865,00 ₺
AFS1 195	1x95	865,00 ₺
AFS1 1120	1x120	950,00 ₺
AFS1 1150	1x150	950,00 ₺
AFS1 1185	1x185	1.070,00 ₺
AFS1 1240	1x240	1.070,00 ₺
AFS1 1300	1x300	1.250,00 ₺

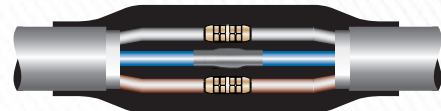

0.6-1 kV



KOD CODE	KABLO KESİTİ CROSS SECTION	FİYAT PRICE
DFS1 31610	3x16+10	975,00 ₺
DFS1 32516	3x25+16	1.010,00 ₺
DFS1 33516	3x35+16	1.100,00 ₺
DFS1 35025	3x50+25	1.140,00 ₺
DFS1 37035	3x70+35	1.390,00 ₺
DFS1 39550	3x95+50	1.490,00 ₺
DFS1 31207	3x120+70	1.665,00 ₺
DFS1 31507	3x150+70	1.970,00 ₺
DFS1 31859	3x185+95	2.230,00 ₺
DFS1 32401	3x240+120	2.580,00 ₺
DFS1 33001	3x300+150	3.080,00 ₺
DFS1 34001	3x400+185	3.350,00 ₺
DFS1 4105	4x1,5	885,00 ₺
DFS1 4205	4x2,5	885,00 ₺
DFS1 404	4x4	885,00 ₺
DFS1 406	4x6	885,00 ₺
DFS1 410	4x10	950,00 ₺
DFS1 416	4x16	985,00 ₺
DFS1 425	4x25	1.020,00 ₺
DFS1 435	4x35	1.110,00 ₺
DFS1 450	4x50	1.150,00 ₺
DFS1 470	4x70	1.400,00 ₺
DFS1 495	4x95	1.500,00 ₺
DFS1 4120	4x120	1.685,00 ₺
DFS1 4150	4x150	1.990,00 ₺
DFS1 4185	4x185	2.250,00 ₺
DFS1 4240	4x240	2.600,00 ₺
DFS1 4300	4x300	3.100,00 ₺
DFS1 4400	4x400	3.400,00 ₺

KOD CODE	KABLO KESİTİ CROSS SECTION	FİYAT PRICE
DFS1 5105-DFS1 5205	5x1,5-5x2,5	925,00 ₺
DFS1 504-DFS1 506	5x4-5x6	925,00 ₺
DFS1 510	5x10	1.000,00 ₺
DFS1 516	5x16	1.050,00 ₺
DFS1 525	5x25	1.095,00 ₺
DFS1 535	5x35	1.220,00 ₺
DFS1 550	5x50	1.330,00 ₺
DFS1 570	5x70	1.510,00 ₺
DFS1 595	5x95	1.800,00 ₺
DFS1 5120	5x120	1.900,00 ₺
DFS1 5150	5x150	2.230,00 ₺
DFS1 5185	5x185	2.540,00 ₺
DFS1 5240	5x240	2.950,00 ₺

KOD CODE	KABLO KESİTİ CROSS SECTION	FİYAT PRICE
DFS1 135	1x35	830,00 ₺
DFS1 150	1x50	830,00 ₺
DFS1 170	1x70	920,00 ₺
DFS1 195	1x95	920,00 ₺
DFS1 1120	1x120	1.020,00 ₺
DFS1 1150	1x150	1.020,00 ₺
DFS1 1185	1x185	1.140,00 ₺
DFS1 1240	1x240	1.140,00 ₺
DFS1 1300	1x300	1.330,00 ₺

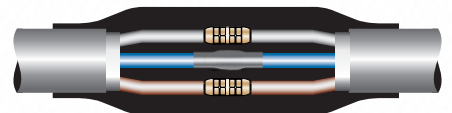



AG 1 kV

Zırlılı İsi Büzüşmeli
Ek Mufları



0.6-1 kV

BAKIR İLETKENLER İÇİN
FOR COPPER CONNECTORS



0.6-1 kV

ALÜMİNYUM İLETKENLER İÇİN
FOR ALUMINUM CONNECTORS



KOD CODE	KABLO KESİTİ CROSS SECTION	FİYAT PRICE
ZS1 4105	4x1,5	285,00 ₺
ZS1 4205	4x2,5	285,00 ₺
ZS1 404	4x4	285,00 ₺
ZS1 406	4x6	285,00 ₺
ZS1 410	4x10	485,00 ₺
ZS1 416	4x16	500,00 ₺
ZS1 425	4x25	575,00 ₺
ZS1 435	4x35	600,00 ₺
ZS1 450	4x50	615,00 ₺
ZS1 470	4x70	930,00 ₺
ZS1 495	4x95	1.130,00 ₺
ZS1 4120	4x120	1.190,00 ₺
ZS1 4150	4x150	1.750,00 ₺
ZS1 4185	4x185	1.880,00 ₺
ZS1 4240	4x240	2.550,00 ₺
ZS1 4300	4x300	2.640,00 ₺
ZS1 4400	4x400	2.800,00 ₺
ZS1 31610	3x16+10	485,00 ₺
ZS1 32516	3x25+16	555,00 ₺
ZS1 33516	3x35+16	580,00 ₺
ZS1 35025	3x50+25	595,00 ₺
ZS1 37035	3x70+35	900,00 ₺
ZS1 39550	3x95+50	1.090,00 ₺
ZS1 31207	3x120+70	1.150,00 ₺
ZS1 31507	3x150+70	1.690,00 ₺
ZS1 31859	3x185+95	1.820,00 ₺
ZS1 32401	3x240+120	2.470,00 ₺
ZS1 33001	3x300+150	2.560,00 ₺
ZS1 34001	3x400+185	2.675,00 ₺

KOD CODE	KABLO KESİTİ CROSS SECTION	FİYAT PRICE
AZS1 425	4x25	565,00 ₺
AZS1 435	4x35	590,00 ₺
AZS1 450	4x50	605,00 ₺
AZS1 470	4x70	920,00 ₺
AZS1 495	4x95	1.120,00 ₺
AZS1 4120	4x120	1.175,00 ₺
AZS1 4150	4x150	1.735,00 ₺
AZS1 4185	4x185	1.865,00 ₺
AZS1 4240	4x240	2.535,00 ₺
AZS1 4300	4x300	2.625,00 ₺
AZS1 4400	4x400	2.785,00 ₺
AZS1 32516	3x25+16	540,00 ₺
AZS1 33516	3x35+16	570,00 ₺
AZS1 35025	3x50+25	580,00 ₺
AZS1 37035	3x70+35	875,00 ₺
AZS1 39550	3x95+50	1.085,00 ₺
AZS1 31207	3x120+70	1.125,00 ₺
AZS1 31507	3x150+70	1.675,00 ₺
AZS1 31859	3x185+95	1.795,00 ₺
AZS1 32401	3x240+120	2.455,00 ₺
AZS1 33001	3x300+150	2.520,00 ₺
AZS1 34001	3x400+185	2.640,00 ₺

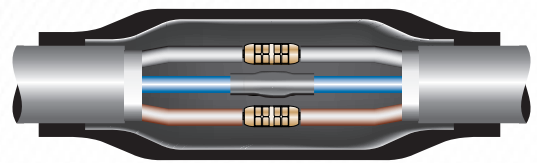

DIN ZIRHLI BAKIR İLETKENLER İÇİN ISI BÜZÜŞMELİ KABLO EK MUFU

FOR DIN ARMOURED COPPER CONNECTORS HEAT SHRINKABLE CABLE JOINT

0.6-1 kV



KOD CODE	KABLO KESİTİ CROSS SECTION	FİYAT PRICE
DZS1 4105	4x1,5	330,00 ₺
DZS1 4205	4x2,5	330,00 ₺
DZS1 404	4x4	330,00 ₺
DZS1 406	4x6	330,00 ₺
DZS1 410	4x10	550,00 ₺
DZS1 416	4x16	565,00 ₺
DZS1 425	4x25	640,00 ₺
DZS1 435	4x35	715,00 ₺
DZS1 450	4x50	750,00 ₺
DZS1 470	4x70	1.050,00 ₺
DZS1 495	4x95	1.290,00 ₺
DZS1 4120	4x120	1.320,00 ₺
DZS1 4150	4x150	2.200,00 ₺
DZS1 4185	4x185	2.250,00 ₺
DZS1 4240	4x240	3.200,00 ₺
DZS1 4300	4x300	3.300,00 ₺
DZS1 4400	4x400	3.500,00 ₺
DZS1 31610	3x16+10	475,00 ₺
DZS1 32516	3x25+16	550,00 ₺
DZS1 33516	3x35+16	565,00 ₺
DZS1 35025	3x50+25	580,00 ₺
DZS1 37035	3x70+35	875,00 ₺
DZS1 39550	3x95+50	1.050,00 ₺
DZS1 31207	3x120+70	1.125,00 ₺
DZS1 31507	3x150+70	1.585,00 ₺
DZS1 31859	3x185+95	1.750,00 ₺
DZS1 32401	3x240+120	2.165,00 ₺
DZS1 33001	3x300+150	2.310,00 ₺
DZS1 34001	3x400+185	2.520,00 ₺

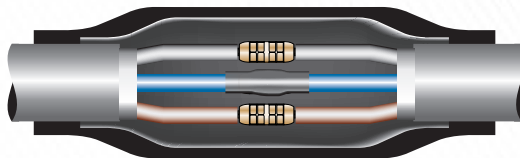



KOD CODE	KABLO KESİTİ CROSS SECTION	FİYAT PRICE
BS1 42516	4x25-4x16	760,00 ₺
BS1 43516	4x35-4x16	760,00 ₺
BS1 45025	4x50-4x25	880,00 ₺
BS1 47035	4x70-4x35	1.095,00 ₺
BS1 49550	4x95-4x50	1.415,00 ₺
BS1 412070	4x120-4x70	1.640,00 ₺
BS1 415095	4x150-4x95	1.905,00 ₺
BS1 4185120	4x185-4x120	3.010,00 ₺
BS1 4240150	4x240-4x150	3.380,00 ₺
BS1 32516	3x25+16-3x16+10	755,00 ₺
BS1 33516	3x35+16-3x25+16	755,00 ₺
BS1 35025	3x50+25-3x25+16	830,00 ₺
BS1 37035	3x70+35-3x35+16	1.045,00 ₺
BS1 39550	3x95+50-3x50+25	1.360,00 ₺
BS1 31207	3x120+70-3x70+35	1.605,00 ₺
BS1 31507	3x150+70-3x70+35	1.845,00 ₺
BS1 31859	3x185+95-3x95+50	2.950,00 ₺
BS1 32401	3x240+120-3x120+70	3.295,00 ₺

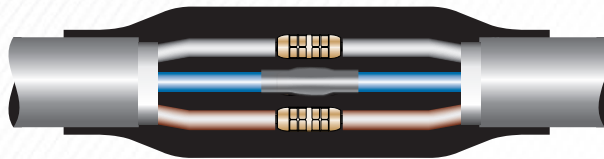

MEKANİK ISI BÜZÜŞMELİ KABLO EK MUFLARI

FOR MECHANIC HEAT SHRINKABLE CABLE JOINTS



0.6-1 kV

KOD CODE	KABLO KESİTİ CROSS SECTION	FİYAT PRICE
MS1 410-435	4x10-4x35	550,00 ₺
MS1 425-450	4x25-4x50	660,00 ₺
MS1 450-495	4x50-4x95	950,00 ₺
MS1 4120-4185	4x120-4x185	1.600,00 ₺
MS1 4240-4300	4x240-4x300	2.450,00 ₺



0.6-1 kV

KOD CODE	KABLO KESİTİ CROSS SECTION	FİYAT PRICE
MS1 310-335	3x10-3x35	495,00 ₺
MS1 325-350	3x25-3x50	590,00 ₺
MS1 350-395	3x50-3x95	860,00 ₺
MS1 3120-3185	3x120-3x185	1.450,00 ₺
MS1 3240-3300	3x240-3x300	2.200,00 ₺

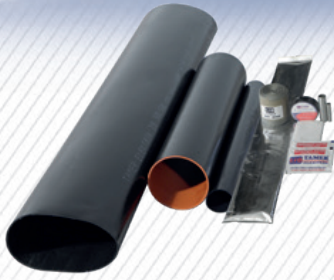

3.5-6 kV

KOD CODE	KABLO KESİTİ CROSS SECTION	KOLİ ADETİ UNIT / BOX	FİYAT PRICE
IB6 125	1x25+16	12	2.500,00 ₺
IB6 135	1x35+16	12	2.500,00 ₺
IB6 150	1x50+16	12	2.500,00 ₺
IB6 170	1x70+16	12	2.500,00 ₺
IB6 195	1x95+16	12	2.500,00 ₺
IB6 1120	1x120+16	12	2.600,00 ₺
IB6 1150	1x150+25	12	2.600,00 ₺
IB6 1185	1x185+25	12	2.600,00 ₺
IB6 1240	1x240+25	12	2.750,00 ₺
IB6 1300	1x300+25	12	3.400,00 ₺
IB6 1400	1x400+35	12	3.900,00 ₺
IB6 1500	1x500+35	12	4.700,00 ₺
IB6 1630	1x630+35	12	5.100,00 ₺

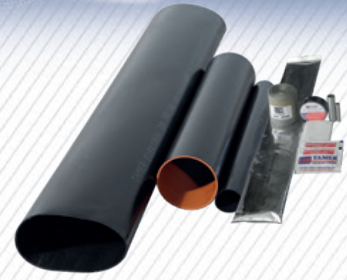

5.8-10 kV

KOD CODE	KABLO KESİTİ CROSS SECTION	KOLİ ADETİ UNIT / BOX	FİYAT PRICE
IB10 125	1x25+16	12	2.500,00 ₺
IB10 135	1x35+16	12	2.500,00 ₺
IB10 150	1x50+16	12	2.500,00 ₺
IB10 170	1x70+16	12	2.500,00 ₺
IB10 195	1x95+16	12	2.500,00 ₺
IB10 1120	1x120+16	12	2.600,00 ₺
IB10 1150	1x150+25	12	2.600,00 ₺
IB10 1185	1x185+25	12	2.600,00 ₺
IB10 1240	1x240+25	12	2.750,00 ₺
IB10 1300	1x300+25	12	3.400,00 ₺
IB10 1400	1x400+35	12	3.900,00 ₺
IB10 1500	1x500+35	12	4.700,00 ₺
IB10 1630	1x630+35	12	5.100,00 ₺

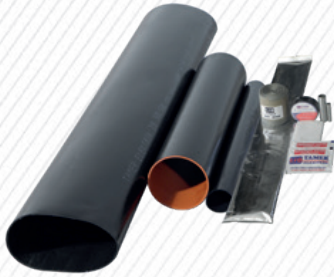

8.7-15 kV

KOD CODE	KABLO KESİTİ CROSS SECTION	KOLİ ADETİ UNIT / BOX	FİYAT PRICE
IB15 125	1x25+16	12	2.500,00 ₺
IB15 135	1x35+16	12	2.500,00 ₺
IB15 150	1x50+16	12	2.500,00 ₺
IB15 170	1x70+16	12	2.500,00 ₺
IB15 195	1x95+16	12	2.500,00 ₺
IB15 1120	1x120+16	12	2.600,00 ₺
IB15 1150	1x150+25	12	2.600,00 ₺
IB15 1185	1x185+25	12	2.600,00 ₺
IB15 1240	1x240+25	12	2.750,00 ₺
IB15 1300	1x300+25	12	3.400,00 ₺
IB15 1400	1x400+35	12	3.900,00 ₺
IB15 1500	1x500+35	12	4.700,00 ₺
IB15 1630	1x630+35	12	5.100,00 ₺

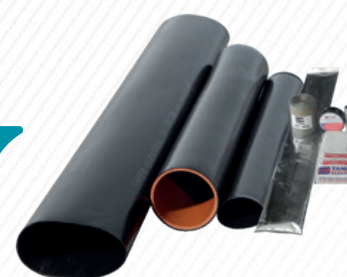

20.8-36 kV

KOD CODE	KABLO KESİTİ CROSS SECTION	KOLİ ADETİ UNIT / BOX	FİYAT PRICE
IB36 125	1x25+16	12	4.200,00 ₺
IB36 135	1x35+16	12	4.200,00 ₺
IB36 150	1x50+16	12	4.200,00 ₺
IB36 170	1x70+16	12	4.200,00 ₺
IB36 195	1x95+16	12	4.200,00 ₺
IB36 1120	1x120+16	12	4.300,00 ₺
IB36 1150	1x150+25	12	4.300,00 ₺
IB36 1185	1x185+25	12	4.480,00 ₺
IB36 1240	1x240+25	12	4.480,00 ₺
IB36 1300	1x300+25	12	4.800,00 ₺
IB36 1400	1x400+35	12	5.300,00 ₺
IB36 1500	1x500+35	12	6.100,00 ₺
IB36 1630	1x630+35	12	6.500,00 ₺

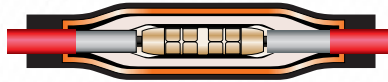

O.G. ÜÇ DAMARLI ISI BÜZÜŞMELİ KABLO EK MUFLARI

M.V. THREE CORES HEAT SHRINKABLE CABLE JOINTS



3.5-6 kV

KOD CODE	KABLO KESİTİ CROSS SECTION	FİYAT PRICE
IB6 325	3x25+16	6.600,00 ₺
IB6 335	3x35+16	6.600,00 ₺
IB6 350	3x50+16	6.640,00 ₺
IB6 370	3x70+16	6.640,00 ₺
IB6 395	3x95+16	6.640,00 ₺
IB6 3120	3x120+16	6.850,00 ₺
IB6 3150	3x150+25	6.850,00 ₺
IB6 3185	3x185+25	6.850,00 ₺
IB6 3240	3x240+25	7.500,00 ₺
IB6 3300	3x300+25	7.900,00 ₺
IB6 3400	3x400+35	8.400,00 ₺
IB6 3500	3x500+35	9.400,00 ₺

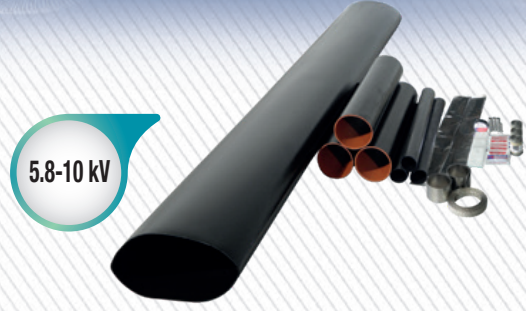

5.8-10 kV

KOD CODE	KABLO KESİTİ CROSS SECTION	FİYAT PRICE
IB10 325	3x25+16	6.600,00 ₺
IB10 335	3x35+16	6.600,00 ₺
IB10 350	3x50+16	6.640,00 ₺
IB10 370	3x70+16	6.640,00 ₺
IB10 395	3x95+16	6.640,00 ₺
IB10 3120	3x120+16	6.850,00 ₺
IB10 3150	3x150+25	6.850,00 ₺
IB10 3185	3x185+25	6.850,00 ₺
IB10 3240	3x240+25	7.500,00 ₺
IB10 3300	3x300+25	7.900,00 ₺
IB10 3400	3x400+35	8.400,00 ₺
IB10 3500	3x500+35	9.400,00 ₺

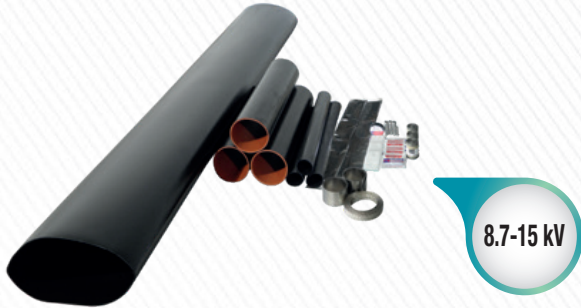

8.7-15 kV

KOD CODE	KABLO KESİTİ CROSS SECTION	FİYAT PRICE
IB15 325	3x25+16	6.600,00 ₺
IB15 335	3x35+16	6.600,00 ₺
IB15 350	3x50+16	6.640,00 ₺
IB15 370	3x70+16	6.640,00 ₺
IB15 395	3x95+16	6.640,00 ₺
IB15 3120	3x120+16	6.850,00 ₺
IB15 3150	3x150+25	6.850,00 ₺
IB15 3185	3x185+25	6.850,00 ₺
IB15 3240	3x240+25	7.500,00 ₺
IB15 3300	3x300+25	7.900,00 ₺
IB15 3400	3x400+35	8.400,00 ₺
IB15 3500	3x500+35	9.400,00 ₺



20.8-36 kV

KOD CODE	KABLO KESİTİ CROSS SECTION	FİYAT PRICE
IB36 325	3x25+16	13.500,00 ₺
IB36 335	3x35+16	13.500,00 ₺
IB36 350	3x50+16	13.500,00 ₺
IB36 370	3x70+16	13.500,00 ₺
IB36 395	3x95+16	13.500,00 ₺
IB36 3120	3x120+16	13.750,00 ₺
IB36 3150	3x150+25	13.750,00 ₺
IB36 3185	3x185+25	14.200,00 ₺
IB36 3240	3x240+25	14.700,00 ₺
IB36 3300	3x300+25	15.300,00 ₺
IB36 3400	3x400+35	15.700,00 ₺
IB36 3500	3x500+35	16.300,00 ₺

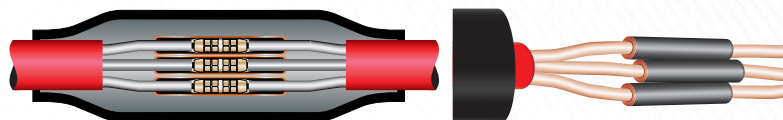

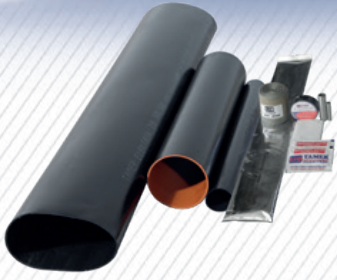

3.5-6 kV

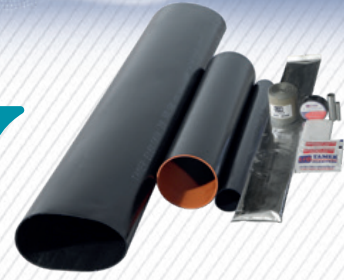

5.8-10 kV

KOD CODE	KABLO KESİTİ CROSS SECTION	KOLİ ADETİ UNIT / BOX	FİYAT PRICE
IBA6 125	1x25+16	12	2.490,00 ₺
IBA6 135	1x35+16	12	2.490,00 ₺
IBA6 150	1x50+16	12	2.490,00 ₺
IBA6 170	1x70+16	12	2.490,00 ₺
IBA6 195	1x95+16	12	2.490,00 ₺
IBA6 1120	1x120+16	12	2.585,00 ₺
IBA6 1150	1x150+25	12	2.585,00 ₺
IBA6 1185	1x185+25	12	2.585,00 ₺
IBA6 1240	1x240+25	12	2.735,00 ₺
IBA6 1300	1x300+25	12	3.385,00 ₺
IBA6 1400	1x400+35	12	3.875,00 ₺
IBA6 1500	1x500+35	12	4.685,00 ₺
IBA6 1630	1x630+35	12	5.085,00 ₺

KOD CODE	KABLO KESİTİ CROSS SECTION	KOLİ ADETİ UNIT / BOX	FİYAT PRICE
IBA10 125	1x25+16	12	2.490,00 ₺
IBA10 135	1x35+16	12	2.490,00 ₺
IBA10 150	1x50+16	12	2.490,00 ₺
IBA10 170	1x70+16	12	2.490,00 ₺
IBA10 195	1x95+16	12	2.490,00 ₺
IBA10 1120	1x120+16	12	2.585,00 ₺
IBA10 1150	1x150+25	12	2.585,00 ₺
IBA10 1185	1x185+25	12	2.585,00 ₺
IBA10 1240	1x240+25	12	2.735,00 ₺
IBA10 1300	1x300+25	12	3.385,00 ₺
IBA10 1400	1x400+35	12	3.875,00 ₺
IBA10 1500	1x500+35	12	4.685,00 ₺
IBA10 1630	1x630+35	12	5.085,00 ₺

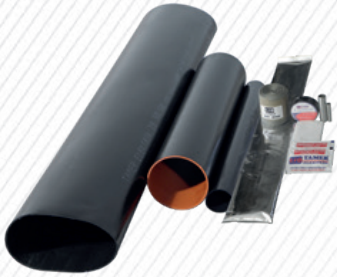

8.7-15 kV

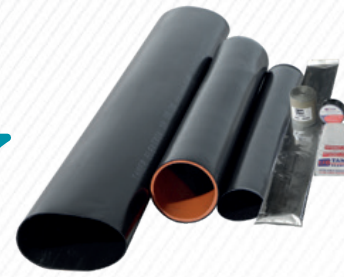

20.8-36 kV

KOD CODE	KABLO KESİTİ CROSS SECTION	KOLİ ADETİ UNIT / BOX	FİYAT PRICE
IBA15 125	1x25+16	12	2.490,00 ₺
IBA15 135	1x35+16	12	2.490,00 ₺
IBA15 150	1x50+16	12	2.490,00 ₺
IBA15 170	1x70+16	12	2.490,00 ₺
IBA15 195	1x95+16	12	2.490,00 ₺
IBA15 1120	1x120+16	12	2.585,00 ₺
IBA15 1150	1x150+25	12	2.585,00 ₺
IBA15 1185	1x185+25	12	2.585,00 ₺
IBA15 1240	1x240+25	12	2.735,00 ₺
IBA15 1300	1x300+25	12	3.385,00 ₺
IBA15 1400	1x400+35	12	3.875,00 ₺
IBA15 1500	1x500+35	12	4.685,00 ₺
IBA15 1630	1x630+35	12	5.085,00 ₺

KOD CODE	KABLO KESİTİ CROSS SECTION	KOLİ ADETİ UNIT / BOX	FİYAT PRICE
IBA36 125	1x25+16	12	4.190,00 ₺
IBA36 135	1x35+16	12	4.190,00 ₺
IBA36 150	1x50+16	12	4.190,00 ₺
IBA36 170	1x70+16	12	4.190,00 ₺
IBA36 195	1x95+16	12	4.190,00 ₺
IBA36 1120	1x120+16	12	4.285,00 ₺
IBA36 1150	1x150+25	12	4.285,00 ₺
IBA36 1185	1x185+25	12	4.465,00 ₺
IBA36 1240	1x240+25	12	4.465,00 ₺
IBA36 1300	1x300+25	12	4.785,00 ₺
IBA36 1400	1x400+35	12	5.285,00 ₺
IBA36 1500	1x500+35	12	6.085,00 ₺
IBA36 1630	1x630+35	12	6.485,00 ₺

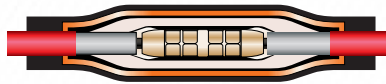

O.G. ALÜMİNYUM ÜÇ DAMARLI ISI BÜZÜŞMELİ KABLO EK MUFLARI

M.V. ALUMINUM THREE CORES HEAT SHRINKABLE CABLE JOINTS

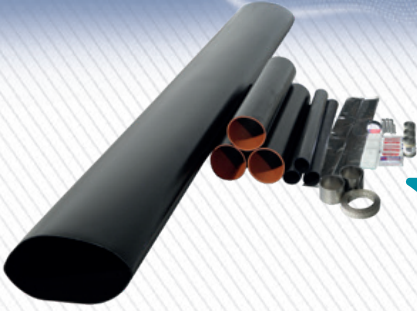

3.5-6 kV

KOD CODE	KABLO KESİTİ CROSS SECTION	FİYAT PRICE
IBA6 325	3X25+16	6.590,00 ₺
IBA6 335	3X35+16	6.590,00 ₺
IBA6 350	3X50+16	6.630,00 ₺
IBA6 370	3X70+16	6.630,00 ₺
IBA6 395	3X95+16	6.630,00 ₺
IBA6 3120	3X120+16	6.835,00 ₺
IBA6 3150	3X150+25	6.835,00 ₺
IBA6 3185	3X185+25	6.835,00 ₺
IBA6 3240	3X240+25	7.485,00 ₺
IBA6 3300	3X300+25	7.885,00 ₺
IBA6 3400	3X400+35	8.385,00 ₺
IBA6 3500	3X500+35	9.385,00 ₺

5.8-10 kV

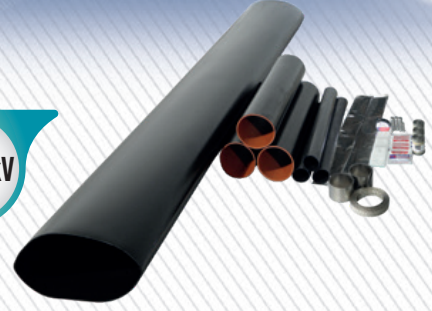

KOD CODE	KABLO KESİTİ CROSS SECTION	FİYAT PRICE
IBA10 325	3X25+16	6.590,00 ₺
IBA10 335	3X35+16	6.590,00 ₺
IBA10 350	3X50+16	6.630,00 ₺
IBA10 370	3X70+16	6.630,00 ₺
IBA10 395	3X95+16	6.630,00 ₺
IBA10 3120	3X120+16	6.835,00 ₺
IBA10 3150	3X150+25	6.835,00 ₺
IBA10 3185	3X185+25	6.835,00 ₺
IBA10 3240	3X240+25	7.485,00 ₺
IBA10 3300	3X300+25	7.885,00 ₺
IBA10 3400	3X400+35	8.385,00 ₺
IBA10 3500	3X500+35	9.385,00 ₺



8.7-15 kV

KOD CODE	KABLO KESİTİ CROSS SECTION	FİYAT PRICE
IBA15 325	3X25+16	6.590,00 ₺
IBA15 335	3X35+16	6.590,00 ₺
IBA15 350	3X50+16	6.630,00 ₺
IBA15 370	3X70+16	6.630,00 ₺
IBA15 395	3X95+16	6.630,00 ₺
IBA15 3120	3X120+16	6.835,00 ₺
IBA15 3150	3X150+25	6.835,00 ₺
IBA15 3185	3X185+25	6.835,00 ₺
IBA15 3240	3X240+25	7.485,00 ₺
IBA15 3300	3X300+25	7.885,00 ₺
IBA15 3400	3X400+35	8.385,00 ₺
IBA15 3500	3X500+35	9.385,00 ₺

20.8-36 kV



KOD CODE	KABLO KESİTİ CROSS SECTION	FİYAT PRICE
IBA36 325	3X25+16	13.490,00 ₺
IBA36 335	3X35+16	13.490,00 ₺
IBA36 350	3X50+16	13.490,00 ₺
IBA36 370	3X70+16	13.490,00 ₺
IBA36 395	3X95+16	13.490,00 ₺
IBA36 3120	3X120+16	13.735,00 ₺
IBA36 3150	3X150+25	13.735,00 ₺
IBA36 3185	3X185+25	14.185,00 ₺
IBA36 3240	3X240+25	14.685,00 ₺
IBA36 3300	3X300+25	15.285,00 ₺
IBA36 3400	3X400+35	15.685,00 ₺
IBA36 3500	3X500+35	16.285,00 ₺

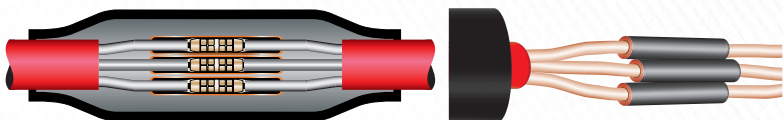



3.5-6 kV



5.8-10 kV

KOD CODE	KABLO KESİTİ CROSS SECTION	KOLİ ADETİ UNIT / BOX	FİYAT PRICE
MIB6 125-195	1x25+16-1x95+16	12	3.700,00 ₺
MIB6 1120-1300	1x120+16-1x300+25	12	4.250,00 ₺

KOD CODE	KABLO KESİTİ CROSS SECTION	KOLİ ADETİ UNIT / BOX	FİYAT PRICE
MIB10 125-195	1x25+16-1x95+16	12	3.700,00 ₺
MIB10 1120-1300	1x120+16-1x300+25	12	4.250,00 ₺

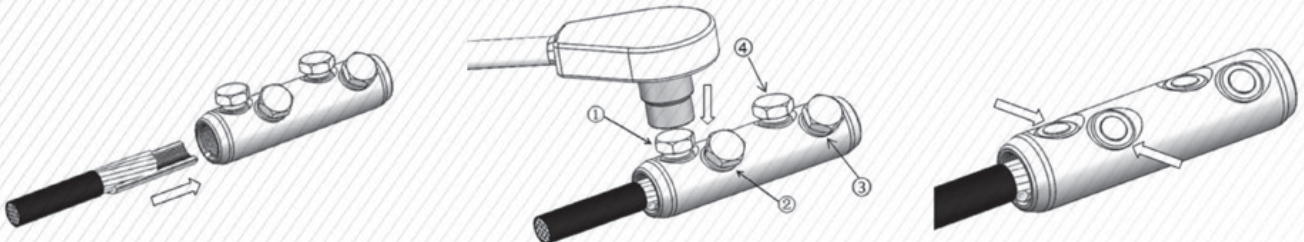

8.7-15 kV

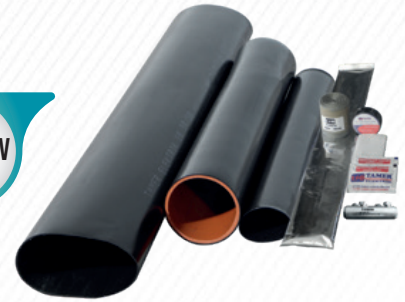

20.8-36 kV

KOD CODE	KABLO KESİTİ CROSS SECTION	KOLİ ADETİ UNIT / BOX	FİYAT PRICE
MIB15 125-195	1x25+16-1x95+16	12	3.700,00 ₺
MIB15 1120-1300	1x120+16-1x300+25	12	4.250,00 ₺

KOD CODE	KABLO KESİTİ CROSS SECTION	KOLİ ADETİ UNIT / BOX	FİYAT PRICE
MIB36 135-170	1x35+16-1x70+16	12	4.950,00 ₺
MIB36 195-1150	1x95+16-1x150+16	12	5.200,00 ₺
MIB36 1185-1400	1x185+25-1x400+25	12	6.500,00 ₺
MIB36 1500-1630	1x1500+35-1x630+35	12	8.250,00 ₺

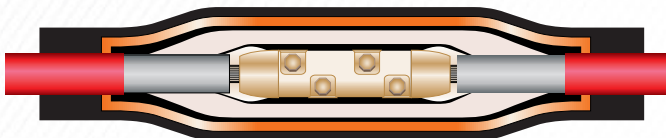

O.G. MEKANİK ÜÇ DAMARLI ISI BÜZÜŞMELİ KABLO EK MUFLARI

M.V. BOLTED THREE CORE HEAT SHRINKABLE CABLE JOINTS



KOD CODE	KABLO KESİTİ CROSS SECTION	FİYAT PRICE
MIB6 325-395	3x25+16-3x95+16	9.250,00 ₺
MIB6 3120-3300	3x120+16-3x300+25	10.750,00 ₺



KOD CODE	KABLO KESİTİ CROSS SECTION	FİYAT PRICE
MIB10 325-395	3x25+16-3x95+16	9.250,00 ₺
MIB10 3120-3300	3x120+16-3x300+25	10.750,00 ₺

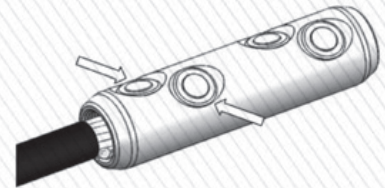
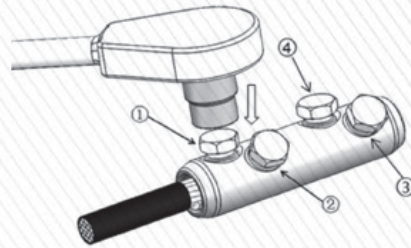
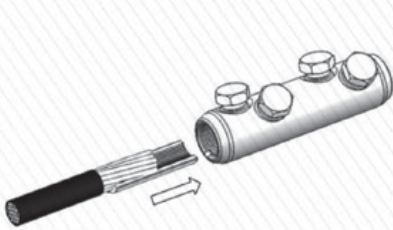

KOD CODE	KABLO KESİTİ CROSS SECTION	FİYAT PRICE
MIB15 325-395	3x25+16-3x95+16	9.250,00 ₺
MIB15 3120-3300	3x120+16-3x300+25	10.750,00 ₺



KOD CODE	KABLO KESİTİ CROSS SECTION	FİYAT PRICE
MIB36 335-370	3x35+16-3x95+16	16.500,00 ₺
MIB36 395-3150	3x120+16-3x300+25	16.900,00 ₺
MIB36 3185-3300	3x185+25-3x300+25	18.500,00 ₺
MIB36 3400-3500	3x400+35-3x500+35	19.500,00 ₺

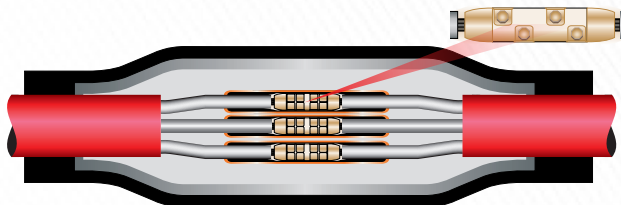



3.5-6 kV

KOD CODE	KABLO KESİTİ CROSS SECTION	FİYAT PRICE
ZIB6 125	1x25+16	7.250,00 ₺
ZIB6 135	1x35+16	7.250,00 ₺
ZIB6 150	1x50+16	7.250,00 ₺
ZIB6 170	1x70+16	7.250,00 ₺
ZIB6 195	1x95+16	7.250,00 ₺
ZIB6 1120	1x120+16	7.400,00 ₺
ZIB6 1150	1x150+25	7.400,00 ₺
ZIB6 1185	1x185+25	7.550,00 ₺
ZIB6 1240	1x240+25	7.550,00 ₺
ZIB6 1300	1x300+25	7.750,00 ₺
ZIB6 1400	1x400+35	8.000,00 ₺
ZIB6 1500	1x500+35	8.650,00 ₺

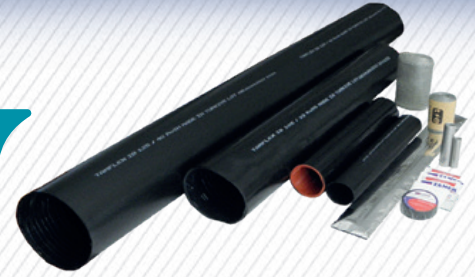

5.8-10 kV

KOD CODE	KABLO KESİTİ CROSS SECTION	FİYAT PRICE
ZIB10 125	1x25+16	7.250,00 ₺
ZIB10 135	1x35+16	7.250,00 ₺
ZIB10 150	1x50+16	7.250,00 ₺
ZIB10 170	1x70+16	7.250,00 ₺
ZIB10 195	1x95+16	7.250,00 ₺
ZIB10 1120	1x120+16	7.400,00 ₺
ZIB10 1150	1x150+25	7.400,00 ₺
ZIB10 1185	1x185+25	7.550,00 ₺
ZIB10 1240	1x240+25	7.550,00 ₺
ZIB10 1300	1x300+25	7.750,00 ₺
ZIB10 1400	1x400+35	8.000,00 ₺
ZIB10 1500	1x500+35	8.650,00 ₺



8.7-15 kV

KOD CODE	KABLO KESİTİ CROSS SECTION	FİYAT PRICE
ZIB15 125	1x25+16	7.250,00 ₺
ZIB15 135	1x35+16	7.250,00 ₺
ZIB15 150	1x50+16	7.250,00 ₺
ZIB15 170	1x70+16	7.250,00 ₺
ZIB15 195	1x95+16	7.250,00 ₺
ZIB15 1120	1x120+16	7.400,00 ₺
ZIB15 1150	1x150+25	7.400,00 ₺
ZIB15 1185	1x185+25	7.550,00 ₺
ZIB15 1240	1x240+25	7.550,00 ₺
ZIB15 1300	1x300+25	7.750,00 ₺
ZIB15 1400	1x400+35	8.000,00 ₺
ZIB15 1500	1x500+35	8.650,00 ₺

20.8-36 kV



KOD CODE	KABLO KESİTİ CROSS SECTION	FİYAT PRICE
ZIB36 125	1x25+16	10.210,00 ₺
ZIB36 135	1x35+16	10.210,00 ₺
ZIB36 150	1x50+16	10.210,00 ₺
ZIB36 170	1x70+16	10.210,00 ₺
ZIB36 195	1x95+16	10.210,00 ₺
ZIB36 1120	1x120+16	10.365,00 ₺
ZIB36 1150	1x150+25	10.365,00 ₺
ZIB36 1185	1x185+25	10.515,00 ₺
ZIB36 1240	1x240+25	10.515,00 ₺
ZIB36 1300	1x300+25	10.915,00 ₺
ZIB36 1400	1x400+35	11.115,00 ₺
ZIB36 1500	1x500+35	11.915,00 ₺

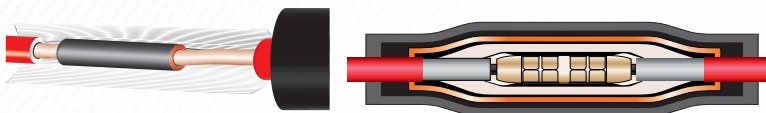

O.G. ZIRHLI BAKIR ÜÇ DAMARLI ISI BÜZÜŞMELİ KABLO EK MUFLARI

M.V. ARMoured COPPER THREE CORES HEAT SHRINKABLE CABLE JOINTS

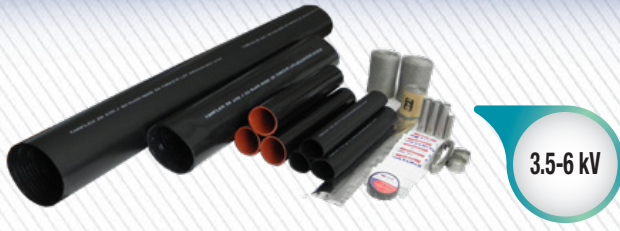

3.5-6 kV



5.8-10 kV

KOD CODE	KABLO KESİTİ CROSS SECTION	FİYAT PRICE
ZIB6 325	3x25+16	13.500,00 ₺
ZIB6 335	3x35+16	13.500,00 ₺
ZIB6 350	3x50+16	13.500,00 ₺
ZIB6 370	3x70+16	13.500,00 ₺
ZIB6 395	3x95+16	13.500,00 ₺
ZIB6 3120	3x120+16	13.700,00 ₺
ZIB6 3150	3x150+25	13.700,00 ₺
ZIB6 3185	3x185+25	13.950,00 ₺
ZIB6 3240	3x240+25	13.950,00 ₺
ZIB6 3300	3x300+25	14.200,00 ₺
ZIB6 3400	3x400+35	14.500,00 ₺
ZIB6 3500	3x500+35	15.250,00 ₺

KOD CODE	KABLO KESİTİ CROSS SECTION	FİYAT PRICE
ZIB10 325	3x25+16	13.500,00 ₺
ZIB10 335	3x35+16	13.500,00 ₺
ZIB10 350	3x50+16	13.500,00 ₺
ZIB10 370	3x70+16	13.500,00 ₺
ZIB10 395	3x95+16	13.500,00 ₺
ZIB10 3120	3x120+16	13.700,00 ₺
ZIB10 3150	3x150+25	13.700,00 ₺
ZIB10 3185	3x185+25	13.950,00 ₺
ZIB10 3240	3x240+25	13.950,00 ₺
ZIB10 3300	3x300+25	14.200,00 ₺
ZIB10 3400	3x400+35	14.500,00 ₺
ZIB10 3500	3x500+35	15.250,00 ₺



8.7-15 kV



20.8-36 kV

KOD CODE	KABLO KESİTİ CROSS SECTION	FİYAT PRICE
ZIB15 325	3x25+16	13.500,00 ₺
ZIB15 335	3x35+16	13.500,00 ₺
ZIB15 350	3x50+16	13.500,00 ₺
ZIB15 370	3x70+16	13.500,00 ₺
ZIB15 395	3x95+16	13.500,00 ₺
ZIB15 3120	3x120+16	13.700,00 ₺
ZIB15 3150	3x150+25	13.700,00 ₺
ZIB15 3185	3x185+25	13.950,00 ₺
ZIB15 3240	3x240+25	13.950,00 ₺
ZIB15 3300	3x300+25	14.200,00 ₺
ZIB15 3400	3x400+35	14.500,00 ₺
ZIB15 3500	3x500+35	15.250,00 ₺

KOD CODE	KABLO KESİTİ CROSS SECTION	FİYAT PRICE
ZIB36 325	3x25+16	17.500,00 ₺
ZIB36 335	3x35+16	17.500,00 ₺
ZIB36 350	3x50+16	17.500,00 ₺
ZIB36 370	3x70+16	17.500,00 ₺
ZIB36 395	3x95+16	17.500,00 ₺
ZIB36 3120	3x120+16	17.700,00 ₺
ZIB36 3150	3x150+25	17.700,00 ₺
ZIB36 3185	3x185+25	17.800,00 ₺
ZIB36 3240	3x240+25	17.800,00 ₺
ZIB36 3300	3x300+25	17.950,00 ₺
ZIB36 3400	3x400+35	18.200,00 ₺
ZIB36 3500	3x500+35	18.900,00 ₺



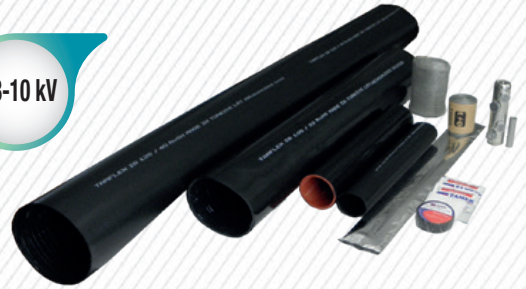
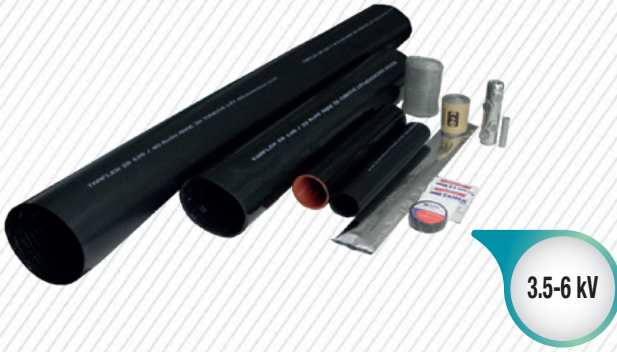

KOD CODE	KABLO KESİTİ CROSS SECTION	FİYAT PRICE
MZIB6 125-195	1x25+16-1x95+16	6.600,00 ₺
MZIB6 1120-1300	1x120+16-1x300+25	7.100,00 ₺

KOD CODE	KABLO KESİTİ CROSS SECTION	FİYAT PRICE
MZIB10 125-195	1x25+16-1x95+16	6.600,00 ₺
MZIB10 1120-1300	1x120+16-1x300+25	7.100,00 ₺

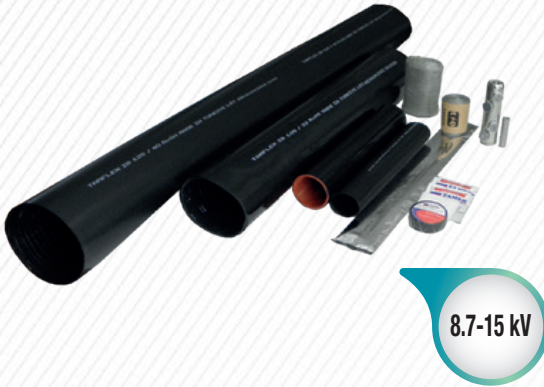
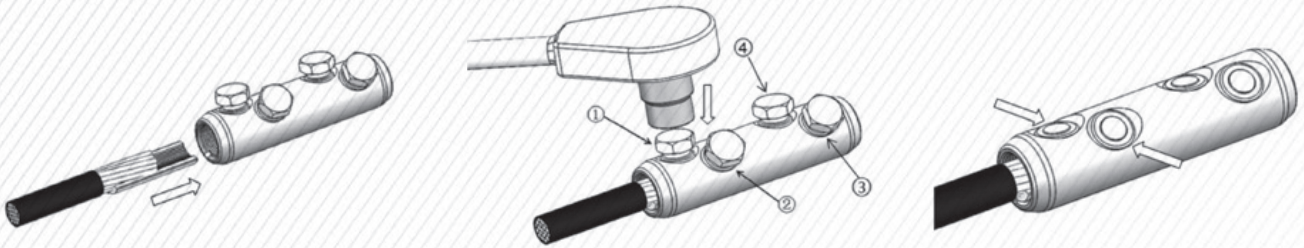

KOD CODE	KABLO KESİTİ CROSS SECTION	FİYAT PRICE
MZIB15 125	1x25+16-1x95+16	6.600,00 ₺
MZIB15 135	1x120+16-1x300+25	7.100,00 ₺

KOD CODE	KABLO KESİTİ CROSS SECTION	FİYAT PRICE
MZIB36 135-170	1x35+16-1x70+16	9.150,00 ₺
MZIB36 195-1150	1x95+16-1x150+16	9.400,00 ₺
MZIB36 1185-1300	1x185+25-1x400+25	9.700,00 ₺
MZIB36 1400-1630	1x1500+35-1x630+35	10.100,00 ₺

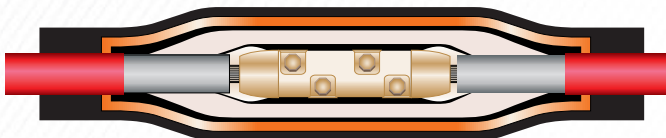

O.G. ZIRHLI MEKANİK ÜÇ DAMARLI ISI BÜZÜŞMELİ KABLO EK MUFLARI

M.V. ARMoured BOLTED THREE CORES HEAT SHRINKABLE CABLE JOINTS



3.5-6 kV

KOD CODE	KABLO KESİTİ CROSS SECTION	FİYAT PRICE
MZIB6 325-395	3x25+16-3x95+16	13.300,00 ₺
MZIB6 3120-3300	3x120+16-3x300+25	14.100,00 ₺

5.8-10 kV



KOD CODE	KABLO KESİTİ CROSS SECTION	FİYAT PRICE
MZIB10 325-395	3x25+16-3x95+16	13.300,00 ₺
MZIB10 3120-3300	3x120+16-3x300+25	14.100,00 ₺

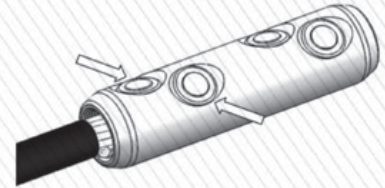
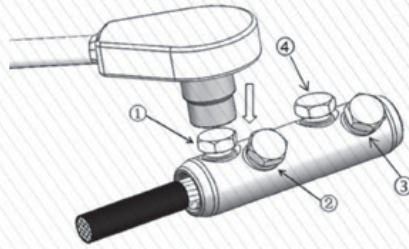
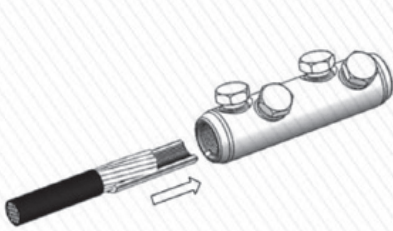

8.7-15 kV

KOD CODE	KABLO KESİTİ CROSS SECTION	FİYAT PRICE
MZIB15 325-395	3x25+16-3x95+16	13.300,00 ₺
MZIB15 3120-3300	3x120+16-3x300+25	14.100,00 ₺

20.8-36 kV



KOD CODE	KABLO KESİTİ CROSS SECTION	FİYAT PRICE
MZIB36 335-370	3x35+16-3x95+16	29.000,00 ₺
MZIB36 395-3150	3x120+16-3x300+25	29.300,00 ₺
MZIB36 3185-3300	3x185+25-3x300+25	29.500,00 ₺
MZIB36 3400-3500	3x400+35-3x500+35	30.500,00 ₺

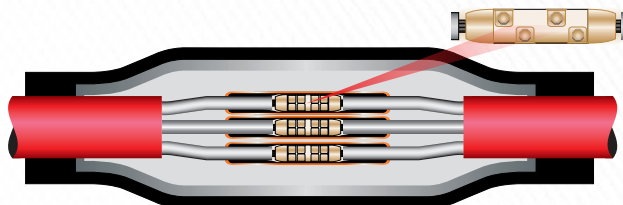

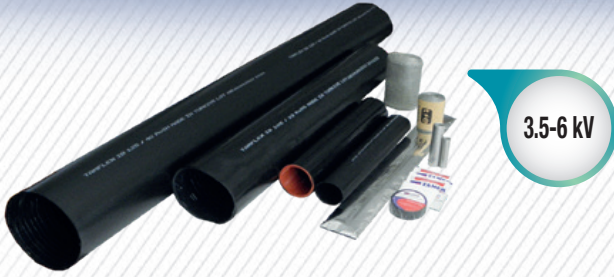

3.5-6 kV



5.8-10 kV

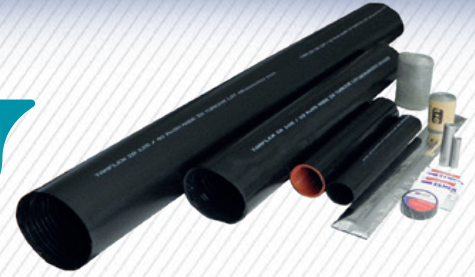

KOD CODE	KABLO KESİTİ CROSS SECTION	FİYAT PRICE
ZIBA6 125	1x25+16	7.240,00 ₺
ZIBA6 135	1x35+16	7.240,00 ₺
ZIBA6 150	1x50+16	7.240,00 ₺
ZIBA6 170	1x70+16	7.240,00 ₺
ZIBA6 195	1x95+16	7.240,00 ₺
ZIBA6 1120	1x120+16	7.385,00 ₺
ZIBA6 1150	1x150+25	7.385,00 ₺
ZIBA6 1185	1x185+25	7.535,00 ₺
ZIBA6 1240	1x240+25	7.535,00 ₺
ZIBA6 1300	1x300+25	7.735,00 ₺
ZIBA6 1400	1x400+35	7.985,00 ₺
ZIBA6 1500	1x500+35	8.635,00 ₺

KOD CODE	KABLO KESİTİ CROSS SECTION	FİYAT PRICE
ZIBA10 125	1x25+16	7.240,00 ₺
ZIBA10 135	1x35+16	7.240,00 ₺
ZIBA10 150	1x50+16	7.240,00 ₺
ZIBA10 170	1x70+16	7.240,00 ₺
ZIBA10 195	1x95+16	7.240,00 ₺
ZIBA10 1120	1x120+16	7.385,00 ₺
ZIBA10 1150	1x150+25	7.385,00 ₺
ZIBA10 1185	1x185+25	7.535,00 ₺
ZIBA10 1240	1x240+25	7.535,00 ₺
ZIBA10 1300	1x300+25	7.735,00 ₺
ZIBA10 1400	1x400+35	7.985,00 ₺
ZIBA10 1500	1x500+35	8.635,00 ₺



8.7-15 kV



20.8-36 kV

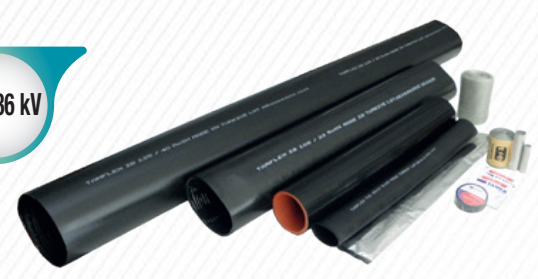

KOD CODE	KABLO KESİTİ CROSS SECTION	FİYAT PRICE
ZIBA15 125	1x25+16	7.240,00 ₺
ZIBA15 135	1x35+16	7.240,00 ₺
ZIBA15 150	1x50+16	7.240,00 ₺
ZIBA15 170	1x70+16	7.240,00 ₺
ZIBA15 195	1x95+16	7.240,00 ₺
ZIBA15 1120	1x120+16	7.385,00 ₺
ZIBA15 1150	1x150+25	7.385,00 ₺
ZIBA15 1185	1x185+25	7.535,00 ₺
ZIBA15 1240	1x240+25	7.535,00 ₺
ZIBA15 1300	1x300+25	7.735,00 ₺
ZIBA15 1400	1x400+35	7.985,00 ₺
ZIBA15 1500	1x500+35	8.635,00 ₺

KOD CODE	KABLO KESİTİ CROSS SECTION	FİYAT PRICE
ZIBA36 125	1x25+16	10.200,00 ₺
ZIBA36 135	1x35+16	10.200,00 ₺
ZIBA36 150	1x50+16	10.200,00 ₺
ZIBA36 170	1x70+16	10.200,00 ₺
ZIBA36 195	1x95+16	10.200,00 ₺
ZIBA36 1120	1x120+16	10.350,00 ₺
ZIBA36 1150	1x150+25	10.350,00 ₺
ZIBA36 1185	1x185+25	10.500,00 ₺
ZIBA36 1240	1x240+25	10.500,00 ₺
ZIBA36 1300	1x300+25	10.900,00 ₺
ZIBA36 1400	1x400+35	11.100,00 ₺
ZIBA36 1500	1x500+35	11.900,00 ₺

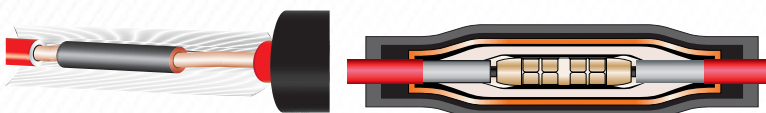

O.G. ZIRHLI ALÜMİNYUM ÜÇ DAMARLI ISI BÜZÜŞMELİ KABLO EK MUFLARI

M.V. ARMOURED ALUMINUM THREE CORES HEAT SHRINKABLE CABLE JOINTS



3.5-6 kV

5.8-10 kV



KOD CODE	KABLO KESİTİ CROSS SECTION	FİYAT PRICE
ZIBA6 325	3x25+16	13.490,00 ₺
ZIBA6 335	3x35+16	13.490,00 ₺
ZIBA6 350	3x50+16	13.490,00 ₺
ZIBA6 370	3x70+16	13.490,00 ₺
ZIBA6 395	3x95+16	13.490,00 ₺
ZIBA6 3120	3x120+16	13.690,00 ₺
ZIBA6 3150	3x150+25	13.690,00 ₺
ZIBA6 3185	3x185+25	13.950,00 ₺
ZIBA6 3240	3x240+25	13.950,00 ₺
ZIBA6 3300	3x300+25	14.200,00 ₺
ZIBA6 3400	3x400+35	14.500,00 ₺
ZIBA6 3500	3x500+35	15.250,00 ₺

KOD CODE	KABLO KESİTİ CROSS SECTION	FİYAT PRICE
ZIBA10 325	3x25+16	5.630,00 ₺
ZIBA10 335	3x35+16	5.630,00 ₺
ZIBA10 350	3x50+16	5.645,00 ₺
ZIBA10 370	3x70+16	5.645,00 ₺
ZIBA10 395	3x95+16	5.645,00 ₺
ZIBA10 3120	3x120+16	5.660,00 ₺
ZIBA10 3150	3x150+25	5.660,00 ₺
ZIBA10 3185	3x185+25	5.660,00 ₺
ZIBA10 3240	3x240+25	5.700,00 ₺
ZIBA10 3300	3x300+25	5.890,00 ₺
ZIBA10 3400	3x400+35	5.990,00 ₺
ZIBA10 3500	3x500+35	6.285,00 ₺



8.7-15 kV

20.8-36 kV



KOD CODE	KABLO KESİTİ CROSS SECTION	FİYAT PRICE
ZIBA15 325	3x25+16	5.630,00 ₺
ZIBA15 335	3x35+16	5.630,00 ₺
ZIBA15 350	3x50+16	5.645,00 ₺
ZIBA15 370	3x70+16	5.645,00 ₺
ZIBA15 395	3x95+16	5.645,00 ₺
ZIBA15 3120	3x120+16	5.660,00 ₺
ZIBA15 3150	3x150+25	5.660,00 ₺
ZIBA15 3185	3x185+25	5.660,00 ₺
ZIBA15 3240	3x240+25	5.700,00 ₺
ZIBA15 3300	3x300+25	5.890,00 ₺
ZIBA15 3400	3x400+35	5.990,00 ₺
ZIBA15 3500	3x500+35	6.285,00 ₺

KOD CODE	KABLO KESİTİ CROSS SECTION	FİYAT PRICE
ZIBA36 325	3x25+16	12.950,00 ₺
ZIBA36 335	3x35+16	12.950,00 ₺
ZIBA36 350	3x50+16	12.950,00 ₺
ZIBA36 370	3x70+16	12.960,00 ₺
ZIBA36 395	3x95+16	12.960,00 ₺
ZIBA36 3120	3x120+16	12.970,00 ₺
ZIBA36 3150	3x150+25	12.970,00 ₺
ZIBA36 3185	3x185+25	12.980,00 ₺
ZIBA36 3240	3x240+25	13.055,00 ₺
ZIBA36 3300	3x300+25	13.285,00 ₺
ZIBA36 3400	3x400+35	13.400,00 ₺
ZIBA36 3500	3x500+35	13.685,00 ₺





PAPUÇSUZ

0.6-1 kV

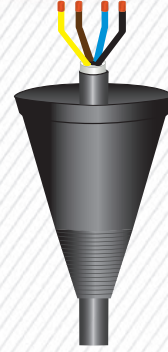

KOD CODE	KABLO KESİTİ CROSS SECTION	KOLİ ADETİ UNIT / BOX	FİYAT PRICE
PKB 01	2X1,5-3X50+25	50	170,00 ₺



0.6-1 kV



KOD CODE	KABLO KESİTİ CROSS SECTION	KOLİ ADETİ UNIT / BOX	FİYAT PRICE
PKB 02	3X70+35-3X95+50	50	240,00 ₺



0.6-1 kV



KOD CODE	KABLO KESİTİ CROSS SECTION	KOLİ ADETİ UNIT / BOX	FİYAT PRICE
PKB 03	3X120+70-3X150+70	32	400,00 ₺

A.G. PABUÇLU REÇİNELİ KABLO BAŞLIKLARI

L. V. WITH LUG RESIN CABLE TERMINATIONS

PAPUÇLU

0.6-1 kV

KOD CODE	KABLO KESİTİ CROSS SECTION	KOLİ ADETİ UNIT / BOX	FİYAT PRICE
B1 504 - B1 506	5 x 4 - 5 x 6	50	630,00 ₺
B1 510	5 x 10	50	640,00 ₺
B1 516	5 x 16	50	645,00 ₺
B1 4105 - B1 4205	4 x 1,5 - 4 x 2,5	50	625,00 ₺
B1 404 - B1 406	4 x 4 - 4 x 6	50	625,00 ₺
B1 410	4 x 10	50	630,00 ₺
B1 416	4 x 16	50	650,00 ₺
B1 31610	3 x 16 + 10	50	640,00 ₺

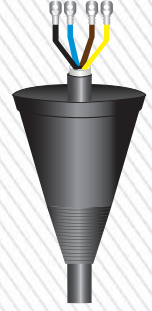

0.6-1 kV

KOD CODE	KABLO KESİTİ CROSS SECTION	KOLİ ADETİ UNIT / BOX	FİYAT PRICE
B1 32516	3x25+16	50	710,00 ₺
B1 33516	3x35+16	50	765,00 ₺
B1 35025	3x50+25	50	830,00 ₺
B1 37035	3x70+35	50	945,00 ₺
B1 39550	3x95+50	50	995,00 ₺



0.6-1 kV

KOD CODE	KABLO KESİTİ CROSS SECTION	KOLİ ADETİ UNIT / BOX	FİYAT PRICE
B1 31207	3x120+70	32	1.130,00 ₺
B1 31507	3x150+70	32	1.190,00 ₺
B1 31859	3x185+95	32	1.415,00 ₺
B1 32401	3x240+120	32	1.565,00 ₺

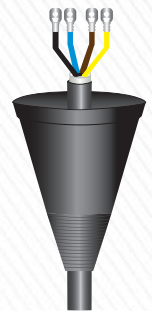

* Alüminyum iletkenli üretim yapılır. / * Production of aluminium conductors are made

PAPUÇLU

0.6-1 kV

KOD CODE	KABLO KESİTİ CROSS SECTION	KOLİ ADETİ UNIT / BOX	FİYAT PRICE
B1 315 - B1 304	3 x 1,5 - 3 x 4	50	610,00 ₺
B1 306 - B1 310	3 x 6 - 3 x 10	50	620,00 ₺
B1 316 - B1 325	3 x 16 - 3 x 25	50	640,00 ₺
B1 335 - B1 350	3 x 35 - 3 x 50	50	810,00 ₺
B1 370 - B1 395	3 x 70 - 3 x 95	50	970,00 ₺
B1 3120 - B1 3150	3 x 120 - 3 x 150	32	1.115,00 ₺
B1 3185	3 x 185	32	1.400,00 ₺
B1 3240	3 x 240	32	1.545,00 ₺



0.6-1 kV

KOD CODE	KABLO KESİTİ CROSS SECTION	KOLİ ADETİ UNIT / BOX	FİYAT PRICE
B1 215 - B1 204	2 x 1,5 - 2 x 4	50	565,00 ₺
B1 206 - B1 210	2 x 6 - 2 x 10	50	570,00 ₺
B1 216 - B1 225	2 x 16 - 2 x 25	50	625,00 ₺
B1 235 - B1 250	2 x 35 - 2 x 50	50	915,00 ₺
B1 270 - B1 295	2 x 70 - 2 x 95	50	925,00 ₺
B1 2120 - B1 2150	2 x 120 - 2 x 150	32	1.105,00 ₺
B1 2185	2 x 185	32	1.385,00 ₺
B1 2240	2 x 240	32	1.445,00 ₺



0.6-1 kV

KOD CODE	KABLO KESİTİ CROSS SECTION	KOLİ ADETİ UNIT / BOX	FİYAT PRICE
B1 115 - B1 104	1 x 1,5 - 1 x 4	50	350,00 ₺
B1 106 - B1 110	1 x 6 - 1 x 10	50	385,00 ₺
B1 116 - B1 125	1 x 16 - 1 x 25	50	415,00 ₺
B1 135 - B1 150	1 x 35 - 1 x 50	50	455,00 ₺
B1 170 - B1 195	1 x 70 - 1 x 95	50	510,00 ₺
B1 1120 - B1 1150	1 x 120 - 1 x 150	32	610,00 ₺
B1 1185	1 x 185	32	665,00 ₺
B1 1240	1 x 240	32	685,00 ₺



AG

Isı Büzüşmeli
Kablo
Başlıkları

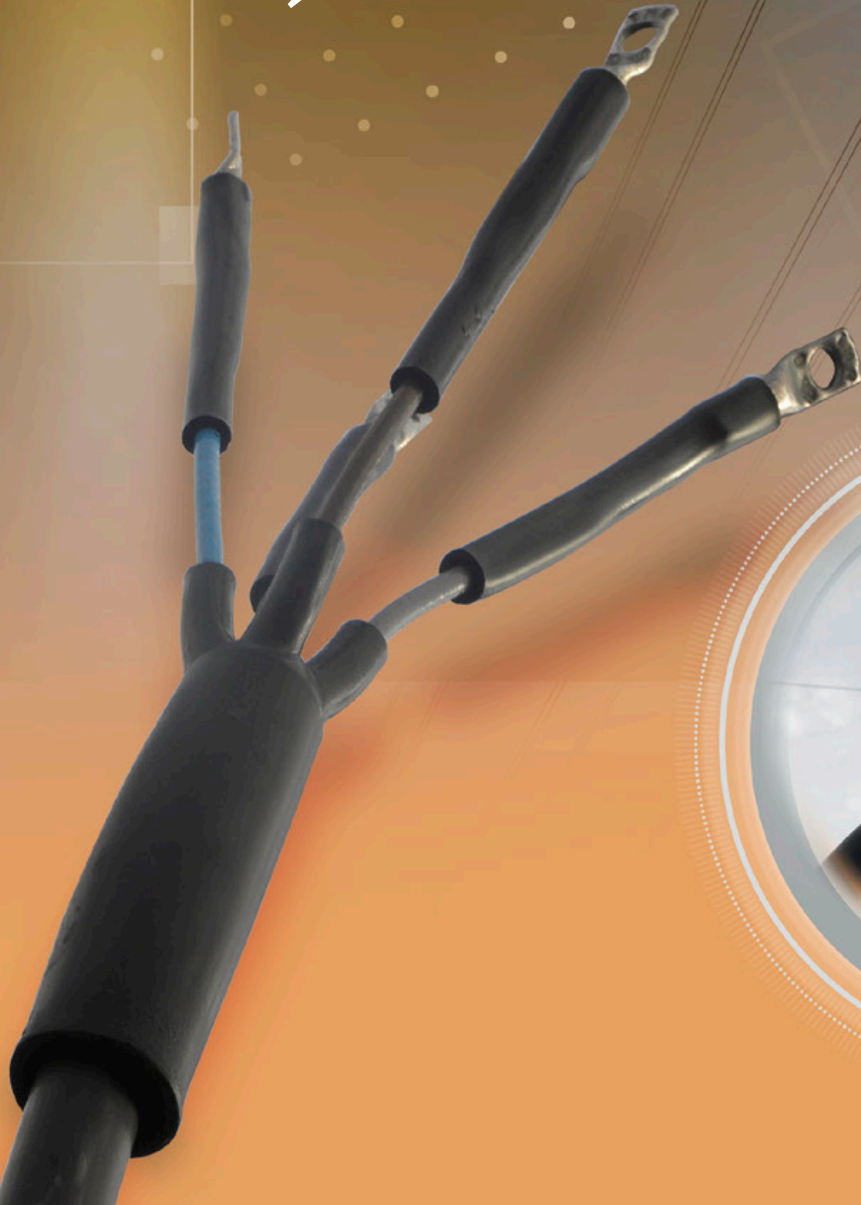

BAKIR İLETKENLER İÇİN

FOR COPPER TERMINATIONS

0.6-1 kV



KOD CODE	KABLO KESİTİ CROSS SECTION	FİYAT PRICE
IBB1 1205	1x2,5	46,00 ₺
IBB1 104	1x4	46,00 ₺
IBB1 106	1x6	46,00 ₺
IBB1 110	1x10	66,00 ₺
IBB1 116	1x16	66,00 ₺
IBB1 125	1x25	82,00 ₺
IBB1 135	1x35	110,00 ₺
IBB1 150	1x50	132,00 ₺
IBB1 170	1x70	150,00 ₺
IBB1 195	1x95	190,00 ₺
IBB1 1120	1x120	228,00 ₺
IBB1 1150	1x150	260,00 ₺
IBB1 1185	1x185	310,00 ₺
IBB1 1240	1x240	390,00 ₺
IBB1 1300	1x300	525,00 ₺
IBB1 1400	1x400	690,00 ₺

ALÜMİNYUM İLETKENLER İÇİN

FOR ALUMINUM TERMINATIONS

0.6-1 kV



KOD CODE	KABLO KESİTİ CROSS SECTION	FİYAT PRICE
AIBB1 110	1x10	61,00 ₺
AIBB1 116	1x16	61,00 ₺
AIBB1 125	1x25	78,00 ₺
AIBB1 135	1x35	100,00 ₺
AIBB1 150	1x50	122,00 ₺
AIBB1 170	1x70	130,00 ₺
AIBB1 195	1x95	158,00 ₺
AIBB1 1120	1x120	170,00 ₺
AIBB1 1150	1x150	195,00 ₺
AIBB1 1185	1x185	210,00 ₺
AIBB1 1240	1x240	255,00 ₺
AIBB1 1300	1x300	315,00 ₺
AIBB1 1400	1x400	440,00 ₺

DIN BAKIR İLETKENLER İÇİN

FOR DIN COPPER TERMINATIONS

KOD CODE	KABLO KESİTİ CROSS SECTION	FİYAT PRICE
DIBB1 116	1x16	72,00 ₺
DIBB1 125	1x25	90,00 ₺
DIBB1 135	1x35	125,00 ₺
DIBB1 150	1x50	150,00 ₺
DIBB1 170	1x70	170,00 ₺
DIBB1 195	1x95	220,00 ₺
DIBB1 1120	1x120	270,00 ₺
DIBB1 1150	1x150	310,00 ₺
DIBB1 1185	1x185	370,00 ₺
DIBB1 1240	1x240	470,00 ₺
DIBB1 1300	1x300	630,00 ₺
DIBB1 1400	1x400	825,00 ₺

0.6-1 kV

AG TEK DAMARLI ISI BÜZÜŞMELİ KABLO BAŞLIKLARI

L.V. SINGLE CORE HEAT SHRINKABLE CABLE TERMINATIONS

MEKANİK İLETKENLER İÇİN

FOR MECHANIC TERMINATIONS

0.6-1 kV



KOD CODE	KABLO KESİTİ CROSS SECTION	FİYAT PRICE
MIBB1 125-195	1x25-1x95	\$26,50
MIBB1 1120-1150	1x120-1x150	\$29,50
MIBB1 1185-1240	1x185-1x240	\$40,50

BİMETAL İLETKENLER İÇİN

FOR BIMETALLIC TERMINATIONS

0.6-1 kV



KOD CODE	KABLO KESİTİ CROSS SECTION	FİYAT PRICE
BIBB1 110	1x10	\$8,15
BIBB1 116	1x16	\$8,15
BIBB1 125	1x25	\$8,15
BIBB1 135	1x35	\$8,15
BIBB1 150	1x50	\$10,60
BIBB1 170	1x70	\$10,60
BIBB1 195	1x95	\$10,60
BIBB1 1120	1x120	\$14,90
BIBB1 1150	1x150	\$14,90
BIBB1 1185	1x185	\$22,35
BIBB1 1240	1x240	\$22,35
BIBB1 1300	1x300	\$34,80
BIBB1 1400	1x400	\$34,80

PAPUÇLU



0.6-1 kV

KOD
CODE

KABLO KESİTİ
CROSS SECTION

FİYAT
PRICE

4 DAMARLI PABUÇLU KABLO BAŞLIĞI

IBB1 4205	4x2,5	490,00 ₺
IBB1 404	4x4	490,00 ₺
IBB1 406	4x6	490,00 ₺
IBB1 410	4x10	500,00 ₺
IBB1 416	4x16	500,00 ₺
IBB1 425	4x25	550,00 ₺
IBB1 435	4x35	600,00 ₺
IBB1 450	4x50	650,00 ₺
IBB1 470	4x70	750,00 ₺
IBB1 495	4x95	850,00 ₺
IBB1 4120	4x120	990,00 ₺
IBB1 4150	4x150	1.150,00 ₺
IBB1 4185	4x185	1.375,00 ₺
IBB1 4240	4x240	1.450,00 ₺
IBB1 4300	4x300	1.950,00 ₺
IBB1 4400	4x400	2.200,00 ₺
IBB1 31610	3x16+10	490,00 ₺
IBB1 32516	3x25+16	540,00 ₺
IBB1 33516	3x35+16	590,00 ₺
IBB1 35025	3x50+25	640,00 ₺
IBB1 37035	3x70+35	740,00 ₺
IBB1 39550	3x95+50	840,00 ₺
IBB1 31207	3x120+70	970,00 ₺
IBB1 31507	3x150+70	1.160,00 ₺
IBB1 31859	3x185+95	1.345,00 ₺
IBB1 32401	3x240+120	1.420,00 ₺
IBB1 33001	3x300+150	1.920,00 ₺
IBB1 34001	3x400+185	2.170,00 ₺

KOD
CODE

KABLO KESİTİ
CROSS SECTION

FİYAT
PRICE

2 DAMARLI PABUÇLU KABLO BAŞLIĞI

IBB1 2205	2x2,5	390,00 ₺
IBB1 204	2x4	390,00 ₺
IBB1 206	2x6	390,00 ₺
IBB1 210	2x10	400,00 ₺
IBB1 216	2x16	400,00 ₺
IBB1 225	2x25	440,00 ₺
IBB1 235	2x35	480,00 ₺
IBB1 250	2x50	520,00 ₺
IBB1 270	2x70	600,00 ₺
IBB1 295	2x95	650,00 ₺
IBB1 2120	2x120	790,00 ₺
IBB1 2150	2x150	920,00 ₺
IBB1 2185	2x185	1.100,00 ₺

KOD
CODE

KABLO KESİTİ
CROSS SECTION

FİYAT
PRICE

5 DAMARLI PABUÇLU KABLO BAŞLIĞI

IBB1 5205	5 x2,5	570,00 ₺
IBB1 504	5 x4	570,00 ₺
IBB1 506	5 x6	570,00 ₺
IBB1 510	5 x10	580,00 ₺
IBB1 516	5 x16	580,00 ₺
IBB1 525	5 x25	635,00 ₺
IBB1 535	5 x35	695,00 ₺
IBB1 550	5 x50	750,00 ₺
IBB1 570	5 x70	870,00 ₺
IBB1 595	5 x95	980,00 ₺
IBB1 5120	5 x120	1.150,00 ₺
IBB1 5150	5 x150	1.300,00 ₺
IBB1 5185	5 x185	1.500,00 ₺



AG BAKIR İLETKENLİ ÇOK DAMARLI ISI BÜZÜŞMELİ KABLO BAŞLIKLARI

L.V. MULTI CORE HEAT SHRINKABLE CABLE TERMINATIONS FOR COPPER CABLE

PAPUÇSUZ

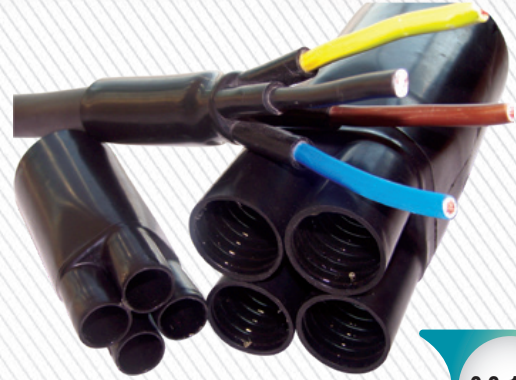

0.6-1 KV

KOD CODE	KABLO KESİTİ CROSS SECTION	FİYAT PRICE
4 DAMARLI PAPUÇSUZ KABLO BAŞLIĞI		
IBBX1 4205	4x2,5	370,00 ₺
IBBX1 404	4x4	370,00 ₺
IBBX1 406	4x6	370,00 ₺
IBBX1 410	4x10	380,00 ₺
IBBX1 416	4x16	380,00 ₺
IBBX1 425	4x25	380,00 ₺
IBBX1 435	4x35	500,00 ₺
IBBX1 450	4x50	500,00 ₺
IBBX1 470	4x70	500,00 ₺
IBBX1 495	4x95	500,00 ₺
IBBX1 4120	4x120	750,00 ₺
IBBX1 4150	4x150	750,00 ₺
IBBX1 4185	4x185	750,00 ₺
IBBX1 4240	4x240	1.100,00 ₺
IBBX1 4300	4x300	1.100,00 ₺
IBBX1 4400	4x400	1.100,00 ₺
IBBX1 31610	3x16+10	380,00 ₺
IBBX1 32516	3x25+16	380,00 ₺
IBBX1 33516	3x35+16	500,00 ₺
IBBX1 35025	3x50+25	500,00 ₺
IBBX1 37035	3x70+35	500,00 ₺
IBBX1 39550	3x95+50	500,00 ₺
IBBX1 31207	3x120+70	750,00 ₺
IBBX1 31507	3x150+70	750,00 ₺
IBBX1 31859	3x185+95	750,00 ₺
IBBX1 32401	3x240+120	1.100,00 ₺
IBBX1 33001	3x300+150	1.100,00 ₺
IBBX1 34001	3x400+185	1.100,00 ₺

KOD CODE	KABLO KESİTİ CROSS SECTION	FİYAT PRICE
2 DAMARLI PAPUÇSUZ KABLO BAŞLIĞI		
IBBX 1 2205	2x2,5	310,00 ₺
IBBX 1 204	2x4	310,00 ₺
IBBX 1 206	2x6	310,00 ₺
IBBX 1 210	2x10	320,00 ₺
IBBX 1 216	2x16	320,00 ₺
IBBX 1 225	2x25	320,00 ₺
IBBX 1 235	2x35	400,00 ₺
IBBX 1 250	2x50	400,00 ₺
IBBX 1 270	2x70	400,00 ₺
IBBX 1 295	2x95	400,00 ₺
IBBX 1 2120	2x120	500,00 ₺
IBBX 1 2150	2x150	500,00 ₺
IBBX 1 2185	2x185	500,00 ₺

KOD CODE	KABLO KESİTİ CROSS SECTION	FİYAT PRICE
5 DAMARLI PAPUÇSUZ KABLO BAŞLIĞI		
IBBX1 5205	5 x2,5	460,00 ₺
IBBX1 504	5 x4	460,00 ₺
IBBX1 506	5 x6	460,00 ₺
IBBX1 510	5 x10	470,00 ₺
IBBX1 516	5 x16	470,00 ₺
IBBX1 525	5 x25	470,00 ₺
IBBX1 535	5 x35	595,00 ₺
IBBX1 550	5 x50	595,00 ₺
IBBX1 570	5 x70	595,00 ₺
IBBX1 595	5 x95	595,00 ₺
IBBX1 5120	5 x120	850,00 ₺
IBBX1 5150	5 x150	850,00 ₺
IBBX1 5185	5 x185	850,00 ₺





KOD CODE	KABLO KESİTİ CROSS SECTION	FİYAT PRICE
4 DAMARLI PABUÇLU KABLO BAŞLIĞI		
AIBB1 4205	4x2,5	475,00 ₺
AIBB1 404	4x4	475,00 ₺
AIBB1 406	4x6	475,00 ₺
AIBB1 410	4x10	485,00 ₺
AIBB1 416	4x16	485,00 ₺
AIBB1 425	4x25	535,00 ₺
AIBB1 435	4x35	585,00 ₺
AIBB1 450	4x50	635,00 ₺
AIBB1 470	4x70	735,00 ₺
AIBB1 495	4x95	835,00 ₺
AIBB1 4120	4x120	965,00 ₺
AIBB1 4150	4x150	1.155,00 ₺
AIBB1 4185	4x185	1.350,00 ₺
AIBB1 4240	4x240	1.415,00 ₺
AIBB1 4300	4x300	1.915,00 ₺
AIBB1 4400	4x400	2.165,00 ₺
AIBB1 31610	3x16+10	475,00 ₺
AIBB1 32516	3x25+16	525,00 ₺
AIBB1 33516	3x35+16	575,00 ₺
AIBB1 35025	3x50+25	625,00 ₺
AIBB1 37035	3x70+35	725,00 ₺
AIBB1 39550	3x95+50	825,00 ₺
AIBB1 31207	3x120+70	945,00 ₺
AIBB1 31507	3x150+70	1.135,00 ₺
AIBB1 31859	3x185+95	1.325,00 ₺
AIBB1 32401	3x240+120	1.385,00 ₺
AIBB1 33001	3x300+150	1.885,00 ₺
AIBB1 34001	3x400+185	2.135,00 ₺

KOD CODE	KABLO KESİTİ CROSS SECTION	FİYAT PRICE
2 DAMARLI PABUÇLU KABLO BAŞLIĞI		
AIBB1 2205	2x2,5	375,00 ₺
AIBB1 204	2x4	375,00 ₺
AIBB1 206	2x6	375,00 ₺
AIBB1 210	2x10	385,00 ₺
AIBB1 216	2x16	385,00 ₺
AIBB1 225	2x25	425,00 ₺
AIBB1 235	2x35	465,00 ₺
AIBB1 250	2x50	505,00 ₺
AIBB1 270	2x70	585,00 ₺
AIBB1 295	2x95	635,00 ₺
AIBB1 2120	2x120	765,00 ₺
AIBB1 2150	2x150	895,00 ₺
AIBB1 2185	2x185	1.075,00 ₺

KOD CODE	KABLO KESİTİ CROSS SECTION	FİYAT PRICE
5 DAMARLI PABUÇLU KABLO BAŞLIĞI		
AIBB1 5205	5 x2,5	555,00 ₺
AIBB1 504	5 x4	555,00 ₺
AIBB1 506	5 x6	555,00 ₺
AIBB1 510	5 x10	565,00 ₺
AIBB1 516	5 x16	565,00 ₺
AIBB1 525	5 x25	620,00 ₺
AIBB1 535	5 x35	680,00 ₺
AIBB1 550	5 x50	735,00 ₺
AIBB1 570	5 x70	855,00 ₺
AIBB1 595	5 x95	965,00 ₺
AIBB1 5120	5 x120	1.125,00 ₺
AIBB1 5150	5 x150	1.275,00 ₺
AIBB1 5185	5 x185	1.475,00 ₺



AG ALÜMİNYUN İLETKENLİ ÇOK DAMARLI ISI BÜZÜŞMELİ KABLO BAŞLIKLARI

L.V. MULTI CORE HEAT SHRINKABLE CABLE TERMINATIONS FOR ALUMINUM CABLE

PAPUÇSUZ

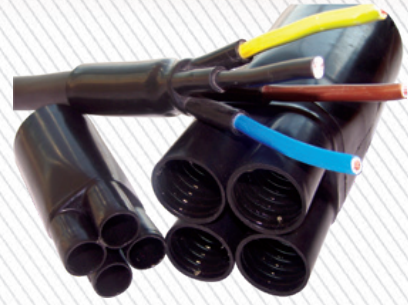
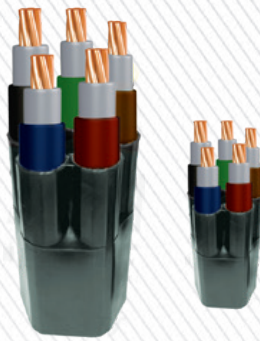

0.6-1 kV

KOD CODE	KABLO KESİTİ CROSS SECTION	FİYAT PRICE
4 DAMARLI PAPUÇSUZ KABLO BAŞLIĞI		
AIBBX1 4205	4x2,5	370,00 ₺
AIBBX1 404	4x4	370,00 ₺
AIBBX1 406	4x6	370,00 ₺
AIBBX1 410	4x10	380,00 ₺
AIBBX1 416	4x16	380,00 ₺
AIBBX1 425	4x25	380,00 ₺
AIBBX1 435	4x35	500,00 ₺
AIBBX1 450	4x50	500,00 ₺
AIBBX1 470	4x70	500,00 ₺
AIBBX1 495	4x95	500,00 ₺
AIBBX1 4120	4x120	750,00 ₺
AIBBX1 4150	4x150	750,00 ₺
AIBBX1 4185	4x185	750,00 ₺
AIBBX1 4240	4x240	1.100,00 ₺
AIBBX1 4300	4x300	1.100,00 ₺
AIBBX1 4400	4x400	1.100,00 ₺
AIBBX1 31610	3x16+10	380,00 ₺
AIBBX1 32516	3x25+16	380,00 ₺
AIBBX1 33516	3x35+16	500,00 ₺
AIBBX1 35025	3x50+25	500,00 ₺
AIBBX1 37035	3x70+35	500,00 ₺
AIBBX1 39550	3x95+50	500,00 ₺
AIBBX1 31207	3x120+70	750,00 ₺
AIBBX1 31507	3x150+70	750,00 ₺
AIBBX1 31859	3x185+95	750,00 ₺
AIBBX1 32401	3x240+120	1.100,00 ₺
AIBBX1 33001	3x300+150	1.100,00 ₺
AIBBX1 34001	3x400+185	1.100,00 ₺

KOD CODE	KABLO KESİTİ CROSS SECTION	FİYAT PRICE
2 DAMARLI PAPUÇSUZ KABLO BAŞLIĞI		
AIBBX1 2205	2x2,5	310,00 ₺
AIBBX1 204	2x4	310,00 ₺
AIBBX1 206	2x6	310,00 ₺
AIBBX1 210	2x10	320,00 ₺
AIBBX1 216	2x16	320,00 ₺
AIBBX1 225	2x25	320,00 ₺
AIBBX1 235	2x35	400,00 ₺
AIBBX1 250	2x50	400,00 ₺
AIBBX1 270	2x70	400,00 ₺
AIBBX1 295	2x95	400,00 ₺
AIBBX1 2120	2x120	500,00 ₺
AIBBX1 2150	2x150	500,00 ₺
AIBBX1 2185	2x185	500,00 ₺

KOD CODE	KABLO KESİTİ CROSS SECTION	FİYAT PRICE
5 DAMARLI PAPUÇSUZ KABLO BAŞLIĞI		
AIBBX1 5205	5 x2,5	460,00 ₺
AIBBX1 504	5 x4	460,00 ₺
AIBBX1 506	5 x6	460,00 ₺
AIBBX1 510	5 x10	470,00 ₺
AIBBX1 516	5 x16	470,00 ₺
AIBBX1 525	5 x25	470,00 ₺
AIBBX1 535	5 x35	595,00 ₺
AIBBX1 550	5 x50	595,00 ₺
AIBBX1 570	5 x70	595,00 ₺
AIBBX1 595	5 x95	595,00 ₺
AIBBX1 5120	5 x120	850,00 ₺
AIBBX1 5150	5 x150	850,00 ₺
AIBBX1 5185	5 x185	850,00 ₺





KOD CODE	KABLO KESİTİ CROSS SECTION	FİYAT PRICE
4 DAMARLI PABUÇLU KABLO BAŞLIĞI		
DIBB1 4205	4x2,5	540,00 ₺
DIBB1 404	4x4	540,00 ₺
DIBB1 406	4x6	540,00 ₺
DIBB1 410	4x10	550,00 ₺
DIBB1 416	4x16	550,00 ₺
DIBB1 425	4x25	605,00 ₺
DIBB1 435	4x35	690,00 ₺
DIBB1 450	4x50	745,00 ₺
DIBB1 470	4x70	860,00 ₺
DIBB1 495	4x95	970,00 ₺
DIBB1 4120	4x120	1.180,00 ₺
DIBB1 4150	4x150	1.380,00 ₺
DIBB1 4185	4x185	1.650,00 ₺
DIBB1 4240	4x240	1.740,00 ₺
DIBB1 4300	4x300	2.340,00 ₺
DIBB1 4400	4x400	2.640,00 ₺
DIBB1 31610	3x16+10	540,00 ₺
DIBB1 32516	3x25+16	595,00 ₺
DIBB1 33516	3x35+16	680,00 ₺
DIBB1 35025	3x50+25	735,00 ₺
DIBB1 37035	3x70+35	850,00 ₺
DIBB1 39550	3x95+50	960,00 ₺
DIBB1 31207	3x120+70	1.160,00 ₺
DIBB1 31507	3x150+70	1.360,00 ₺
DIBB1 31859	3x185+95	1.620,00 ₺
DIBB1 32401	3x240+120	1.710,00 ₺
DIBB1 33001	3x300+150	2.310,00 ₺
DIBB1 34001	3x400+185	2.610,00 ₺

KOD CODE	KABLO KESİTİ CROSS SECTION	FİYAT PRICE
2 DAMARLI PABUÇLU KABLO BAŞLIĞI		
DIBB1 2205	2x2,5	465,00 ₺
DIBB1 204	2x4	465,00 ₺
DIBB1 206	2x6	465,00 ₺
DIBB1 210	2x10	480,00 ₺
DIBB1 216	2x16	480,00 ₺
DIBB1 225	2x25	525,00 ₺
DIBB1 235	2x35	570,00 ₺
DIBB1 250	2x50	620,00 ₺
DIBB1 270	2x70	720,00 ₺
DIBB1 295	2x95	780,00 ₺
DIBB1 2120	2x120	945,00 ₺
DIBB1 2150	2x150	1.090,00 ₺
DIBB1 2185	2x185	1.320,00 ₺

KOD CODE	KABLO KESİTİ CROSS SECTION	FİYAT PRICE
5 DAMARLI PABUÇLU KABLO BAŞLIĞI		
DIBB1 5205	5 x2,5	680,00 ₺
DIBB1 504	5 x4	680,00 ₺
DIBB1 506	5 x6	680,00 ₺
DIBB1 510	5 x10	690,00 ₺
DIBB1 516	5 x16	690,00 ₺
DIBB1 525	5 x25	760,00 ₺
DIBB1 535	5 x35	830,00 ₺
DIBB1 550	5 x50	900,00 ₺
DIBB1 570	5 x70	1.040,00 ₺
DIBB1 595	5 x95	1.175,00 ₺
DIBB1 5120	5 x120	1.380,00 ₺
DIBB1 5150	5 x150	1.560,00 ₺
DIBB1 5185	5 x185	1.800,00 ₺



36 KV

OG

Isı
Büzüşmeli
Kablo
Başlıkları





3.5-6 kV



5.8-10 kV

KOD CODE	KABLO KESİTİ CROSS SECTION	KOLİ ADETİ UNIT / BOX	FİYAT PRICE
IBH6 125	1x25+16	21	1.160,00 ₺
IBH6 135	1x35+16	21	1.160,00 ₺
IBH6 150	1x50+16	21	1.160,00 ₺
IBH6 170	1x70+16	21	1.170,00 ₺
IBH6 195	1x95+16	21	1.170,00 ₺
IBH6 1120	1x120+16	21	1.300,00 ₺
IBH6 1150	1x150+25	21	1.300,00 ₺
IBH6 1185	1x185+25	21	1.320,00 ₺
IBH6 1240	1x240+25	21	1.320,00 ₺
IBH6 1300	1x300+25	21	1.510,00 ₺
IBH6 1400	1x400+35	21	1.710,00 ₺
IBH6 1500	1x500+35	21	2.250,00 ₺
IBH6 1630	1x630+35	21	3.100,00 ₺

HARİCİ

KOD CODE	KABLO KESİTİ CROSS SECTION	KOLİ ADETİ UNIT / BOX	FİYAT PRICE
IBH10 125	1x25+16	21	1.160,00 ₺
IBH10 135	1x35+16	21	1.160,00 ₺
IBH10 150	1x50+16	21	1.160,00 ₺
IBH10 170	1x70+16	21	1.170,00 ₺
IBH10 195	1x95+16	21	1.170,00 ₺
IBH10 1120	1x120+16	21	1.300,00 ₺
IBH10 1150	1x150+25	21	1.300,00 ₺
IBH10 1185	1x185+25	21	1.320,00 ₺
IBH10 1240	1x240+25	21	1.320,00 ₺
IBH10 1300	1x300+25	21	1.510,00 ₺
IBH10 1400	1x400+35	21	1.710,00 ₺
IBH10 1500	1x500+35	21	2.250,00 ₺
IBH10 1630	1x630+35	21	3.100,00 ₺



8.7-15 kV



20.8-36 kV

KOD CODE	KABLO KESİTİ CROSS SECTION	KOLİ ADETİ UNIT / BOX	FİYAT PRICE
IBH15 125	1x25+16	21	1.160,00 ₺
IBH15 135	1x35+16	21	1.160,00 ₺
IBH15 150	1x50+16	21	1.160,00 ₺
IBH15 170	1x70+16	21	1.170,00 ₺
IBH15 195	1x95+16	21	1.170,00 ₺
IBH15 1120	1x120+16	21	1.300,00 ₺
IBH15 1150	1x150+25	21	1.300,00 ₺
IBH15 1185	1x185+25	21	1.320,00 ₺
IBH15 1240	1x240+25	21	1.320,00 ₺
IBH15 1300	1x300+25	21	1.510,00 ₺
IBH15 1400	1x400+35	21	1.710,00 ₺
IBH15 1500	1x500+35	21	2.250,00 ₺
IBH15 1630	1x630+35	21	3.100,00 ₺

HARİCİ

KOD CODE	KABLO KESİTİ CROSS SECTION	KOLİ ADETİ UNIT / BOX	FİYAT PRICE
IBH36 125	1x25+16	21	1.485,00 ₺
IBH36 135	1x35+16	21	1.485,00 ₺
IBH36 150	1x50+16	21	1.485,00 ₺
IBH36 170	1x70+16	21	1.500,00 ₺
IBH36 195	1x95+16	21	1.500,00 ₺
IBH36 1120	1x120+16	21	1.670,00 ₺
IBH36 1150	1x150+25	21	1.670,00 ₺
IBH36 1185	1x185+25	21	1.685,00 ₺
IBH36 1240	1x240+25	21	1.685,00 ₺
IBH36 1300	1x300+25	21	2.100,00 ₺
IBH36 1400	1x400+35	21	3.200,00 ₺
IBH36 1500	1x500+35	21	3.500,00 ₺
IBH36 1630	1x630+35	21	3.900,00 ₺



O.G. BAKIR ÜÇ DAMARLI HARİCİ ISI BÜZÜŞMELİ KABLO BAŞLIKLARI

M.V. COPPER THREE CORES OUTDOOR HEAT SHRINKABLE CABLE TERMINATIONS



3.5-6 kV



5.8-10 kV

KOD CODE	KABLO KESİTİ CROSS SECTION	FİYAT PRICE
IBH6 325	3x25+16	4.300,00 ₺
IBH6 335	3x35+16	4.300,00 ₺
IBH6 350	3x50+16	4.370,00 ₺
IBH6 370	3x70+16	4.370,00 ₺
IBH6 395	3x95+16	4.450,00 ₺
IBH6 3120	3x120+16	4.900,00 ₺
IBH6 3150	3x150+25	4.900,00 ₺
IBH6 3185	3x185+25	5.000,00 ₺
IBH6 3240	3x240+25	5.000,00 ₺
IBH6 3300	3x300+25	5.150,00 ₺
IBH6 3400	3x400+35	5.150,00 ₺

H
A
R
I
C
I

KOD CODE	KABLO KESİTİ CROSS SECTION	FİYAT PRICE
IBH10 325	3x25+16	4.300,00 ₺
IBH10 335	3x35+16	4.300,00 ₺
IBH10 350	3x50+16	4.370,00 ₺
IBH10 370	3x70+16	4.370,00 ₺
IBH10 395	3x95+16	4.450,00 ₺
IBH10 3120	3x120+16	4.900,00 ₺
IBH10 3150	3x150+25	4.900,00 ₺
IBH10 3185	3x185+25	5.000,00 ₺
IBH10 3240	3x240+25	5.000,00 ₺
IBH10 3300	3x300+25	5.150,00 ₺
IBH10 3400	3x400+35	5.150,00 ₺



8.7-15 kV



20.8-36 kV

KOD CODE	KABLO KESİTİ CROSS SECTION	FİYAT PRICE
IBH15 325	3x25+16	4.300,00 ₺
IBH15 335	3x35+16	4.300,00 ₺
IBH15 350	3x50+16	4.370,00 ₺
IBH15 370	3x70+16	4.370,00 ₺
IBH15 395	3x95+16	4.450,00 ₺
IBH15 3120	3x120+16	4.900,00 ₺
IBH15 3150	3x150+25	4.900,00 ₺
IBH15 3185	3x185+25	5.000,00 ₺
IBH15 3240	3x240+25	5.000,00 ₺
IBH15 3300	3x300+25	5.150,00 ₺
IBH15 3400	3x400+35	5.150,00 ₺

H
A
R
I
C
I

KOD CODE	KABLO KESİTİ CROSS SECTION	FİYAT PRICE
IBH36 325	3x25+16	6.310,00 ₺
IBH36 335	3x35+16	6.310,00 ₺
IBH36 350	3x50+16	6.310,00 ₺
IBH36 370	3x70+16	6.380,00 ₺
IBH36 395	3x95+16	6.380,00 ₺
IBH36 3120	3x120+16	6.500,00 ₺
IBH36 3150	3x150+25	6.500,00 ₺
IBH36 3185	3x185+25	6.600,00 ₺
IBH36 3240	3x240+25	6.600,00 ₺
IBH36 3300	3x300+25	6.700,00 ₺
IBH36 3400	3x400+35	7.100,00 ₺





3.5-6 kV



5.8-10 kV

KOD CODE	KABLO KESİTİ CROSS SECTION	KOLİ ADETİ UNIT / BOX	FİYAT PRICE
IBHA6 125	1x25+16	21	1.150,00 ₺
IBHA6 135	1x35+16	21	1.150,00 ₺
IBHA6 150	1x50+16	21	1.150,00 ₺
IBHA6 170	1x70+16	21	1.160,00 ₺
IBHA6 195	1x95+16	21	1.160,00 ₺
IBHA6 1120	1x120+16	21	1.280,00 ₺
IBHA6 1150	1x150+25	21	1.280,00 ₺
IBHA6 1185	1x185+25	21	1.300,00 ₺
IBHA6 1240	1x240+25	21	1.300,00 ₺
IBHA6 1300	1x300+25	21	1.490,00 ₺
IBHA6 1400	1x400+35	21	1.690,00 ₺
IBHA6 1500	1x500+35	21	2.230,00 ₺
IBHA6 1630	1x630+35	21	3.070,00 ₺

HARİCİ

KOD CODE	KABLO KESİTİ CROSS SECTION	KOLİ ADETİ UNIT / BOX	FİYAT PRICE
IBHA10 125	1x25+16	21	1.150,00 ₺
IBHA10 135	1x35+16	21	1.150,00 ₺
IBHA10 150	1x50+16	21	1.150,00 ₺
IBHA10 170	1x70+16	21	1.160,00 ₺
IBHA10 195	1x95+16	21	1.160,00 ₺
IBHA10 1120	1x120+16	21	1.280,00 ₺
IBHA10 1150	1x150+25	21	1.280,00 ₺
IBHA10 1185	1x185+25	21	1.300,00 ₺
IBHA10 1240	1x240+25	21	1.300,00 ₺
IBHA10 1300	1x300+25	21	1.490,00 ₺
IBHA10 1400	1x400+35	21	1.690,00 ₺
IBHA10 1500	1x500+35	21	2.230,00 ₺
IBHA10 1630	1x630+35	21	3.070,00 ₺



8.7-15 kV



20.8-36 kV

KOD CODE	KABLO KESİTİ CROSS SECTION	KOLİ ADETİ UNIT / BOX	FİYAT PRICE
IBHA15 125	1x25+16	21	1.150,00 ₺
IBHA15 135	1x35+16	21	1.150,00 ₺
IBHA15 150	1x50+16	21	1.150,00 ₺
IBHA15 170	1x70+16	21	1.160,00 ₺
IBHA15 195	1x95+16	21	1.160,00 ₺
IBHA15 1120	1x120+16	21	1.280,00 ₺
IBHA15 1150	1x150+25	21	1.280,00 ₺
IBHA15 1185	1x185+25	21	1.300,00 ₺
IBHA15 1240	1x240+25	21	1.300,00 ₺
IBHA15 1300	1x300+25	21	1.490,00 ₺
IBHA15 1400	1x400+35	21	1.690,00 ₺
IBHA15 1500	1x500+35	21	2.230,00 ₺
IBHA15 1630	1x630+35	21	3.070,00 ₺

HARİCİ

KOD CODE	KABLO KESİTİ CROSS SECTION	KOLİ ADETİ UNIT / BOX	FİYAT PRICE
IBHA36 125	1x25+16	21	1.475,00 ₺
IBHA36 135	1x35+16	21	1.475,00 ₺
IBHA36 150	1x50+16	21	1.475,00 ₺
IBHA36 170	1x70+16	21	1.490,00 ₺
IBHA36 195	1x95+16	21	1.490,00 ₺
IBHA36 1120	1x120+16	21	1.650,00 ₺
IBHA36 1150	1x150+25	21	1.650,00 ₺
IBHA36 1185	1x185+25	21	1.665,00 ₺
IBHA36 1240	1x240+25	21	1.665,00 ₺
IBHA36 1300	1x300+25	21	2.080,00 ₺
IBHA36 1400	1x400+35	21	3.180,00 ₺
IBHA36 1500	1x500+35	21	3.480,00 ₺
IBHA36 1630	1x630+35	21	3.870,00 ₺



O.G. ALÜMİNYUM ÜÇ DAMARLI HARİCİ ISI BÜZÜŞMELİ KABLO BAŞLIKLARI

M.V. ALUMINUM THREE CORES OUTDOOR HEAT SHRINKABLE CABLE TERMINATIONS



3.5-6 kV

KOD CODE	KABLO KESİTİ CROSS SECTION	FİYAT PRICE
IBHA6 325	3x25+16	4.290,00 ₺
IBHA6 335	3x35+16	4.290,00 ₺
IBHA6 350	3x50+16	4.360,00 ₺
IBHA6 370	3x70+16	4.360,00 ₺
IBHA6 395	3x95+16	4.440,00 ₺
IBHA6 3120	3x120+16	4.880,00 ₺
IBHA6 3150	3x150+25	4.880,00 ₺
IBHA6 3185	3x185+25	4.980,00 ₺
IBHA6 3240	3x240+25	4.980,00 ₺
IBHA6 3300	3x300+25	5.130,00 ₺
IBHA6 3400	3x400+35	5.130,00 ₺



5.8-10 kV

KOD CODE	KABLO KESİTİ CROSS SECTION	FİYAT PRICE
IBHA10 325	3x25+16	4.290,00 ₺
IBHA10 335	3x35+16	4.290,00 ₺
IBHA10 350	3x50+16	4.360,00 ₺
IBHA10 370	3x70+16	4.360,00 ₺
IBHA10 395	3x95+16	4.440,00 ₺
IBHA10 3120	3x120+16	4.880,00 ₺
IBHA10 3150	3x150+25	4.880,00 ₺
IBHA10 3185	3x185+25	4.980,00 ₺
IBHA10 3240	3x240+25	4.980,00 ₺
IBHA10 3300	3x300+25	5.130,00 ₺
IBHA10 3400	3x400+35	5.130,00 ₺

HARİCİ



8.7-15 kV

KOD CODE	KABLO KESİTİ CROSS SECTION	FİYAT PRICE
IBHA15 325	3x25+16	4.290,00 ₺
IBHA15 335	3x35+16	4.290,00 ₺
IBHA15 350	3x50+16	4.360,00 ₺
IBHA15 370	3x70+16	4.360,00 ₺
IBHA15 395	3x95+16	4.440,00 ₺
IBHA15 3120	3x120+16	4.880,00 ₺
IBHA15 3150	3x150+25	4.880,00 ₺
IBHA15 3185	3x185+25	4.980,00 ₺
IBHA15 3240	3x240+25	4.980,00 ₺
IBHA15 3300	3x300+25	5.130,00 ₺
IBHA15 3400	3x400+35	5.130,00 ₺



20.8-36 kV

KOD CODE	KABLO KESİTİ CROSS SECTION	FİYAT PRICE
IBHA36 325	3x25+16	6.300,00 ₺
IBHA36 335	3x35+16	6.300,00 ₺
IBHA36 350	3x50+16	6.300,00 ₺
IBHA36 370	3x70+16	6.370,00 ₺
IBHA36 395	3x95+16	6.370,00 ₺
IBHA36 3120	3x120+16	6.480,00 ₺
IBHA36 3150	3x150+25	6.480,00 ₺
IBHA36 3185	3x185+25	6.580,00 ₺
IBHA36 3240	3x240+25	6.580,00 ₺
IBHA36 3300	3x300+25	6.680,00 ₺
IBHA36 3400	3x400+35	7.070,00 ₺

HARİCİ





KOD CODE	KABLO KESİTİ CROSS SECTION	KOLİ ADETİ UNIT / BOX	FİYAT PRICE
IBHB6 125	1x25+16	21	1.500,00 ₺
IBHB6 135	1x35+16	21	1.500,00 ₺
IBHB6 150	1x50+16	21	1.500,00 ₺
IBHB6 170	1x70+16	21	1.550,00 ₺
IBHB6 195	1x95+16	21	1.550,00 ₺
IBHB6 1120	1x120+16	21	1.650,00 ₺
IBHB6 1150	1x150+25	21	1.650,00 ₺
IBHB6 1185	1x185+25	21	1.900,00 ₺
IBHB6 1240	1x240+25	21	1.900,00 ₺
IBHB6 1300	1x300+25	21	2.200,00 ₺
IBHB6 1400	1x400+35	21	2.200,00 ₺

KOD CODE	KABLO KESİTİ CROSS SECTION	KOLİ ADETİ UNIT / BOX	FİYAT PRICE
IBHB10 125	1x25+16	21	1.500,00 ₺
IBHB10 135	1x35+16	21	1.500,00 ₺
IBHB10 150	1x50+16	21	1.500,00 ₺
IBHB10 170	1x70+16	21	1.550,00 ₺
IBHB10 195	1x95+16	21	1.550,00 ₺
IBHB10 1120	1x120+16	21	1.650,00 ₺
IBHB10 1150	1x150+25	21	1.650,00 ₺
IBHB10 1185	1x185+25	21	1.900,00 ₺
IBHB10 1240	1x240+25	21	1.900,00 ₺
IBHB10 1300	1x300+25	21	2.200,00 ₺
IBHB10 1400	1x400+35	21	2.200,00 ₺

H
A
R
I
C
I



KOD CODE	KABLO KESİTİ CROSS SECTION	KOLİ ADETİ UNIT / BOX	FİYAT PRICE
IBHB15 125	1x25+16	21	1.500,00 ₺
IBHB15 135	1x35+16	21	1.500,00 ₺
IBHB15 150	1x50+16	21	1.500,00 ₺
IBHB15 170	1x70+16	21	1.550,00 ₺
IBHB15 195	1x95+16	21	1.550,00 ₺
IBHB15 1120	1x120+16	21	1.650,00 ₺
IBHB15 1150	1x150+25	21	1.650,00 ₺
IBHB15 1185	1x185+25	21	1.900,00 ₺
IBHB15 1240	1x240+25	21	1.900,00 ₺
IBHB15 1300	1x300+25	21	2.200,00 ₺
IBHB15 1400	1x400+35	21	2.200,00 ₺

KOD CODE	KABLO KESİTİ CROSS SECTION	KOLİ ADETİ UNIT / BOX	FİYAT PRICE
IBHB36 125	1x25+16	21	1.750,00 ₺
IBHB36 135	1x35+16	21	1.750,00 ₺
IBHB36 150	1x50+16	21	1.750,00 ₺
IBHB36 170	1x70+16	21	1.800,00 ₺
IBHB36 195	1x95+16	21	1.800,00 ₺
IBHB36 1120	1x120+16	21	1.900,00 ₺
IBHB36 1150	1x150+25	21	1.900,00 ₺
IBHB36 1185	1x185+25	21	2.200,00 ₺
IBHB36 1240	1x240+25	21	2.200,00 ₺
IBHB36 1300	1x300+25	21	2.800,00 ₺
IBHB36 1400	1x400+35	21	2.800,00 ₺

H
A
R
I
C
I

O.G. BİMETAL 3 DAMARLI HARİCİ ISI BÜZÜŞMELİ KABLO BAŞLIKLARI

M.V. BIMETALLIC 3 CORE OUTDOOR HEAT SHRINKABLE CABLE TERMINATIONS



KOD CODE	KABLO KESİTİ CROSS SECTION	FİYAT PRICE
IBHB6 325	3x25+16	4.700,00 ₺
IBHB6 335	3x35+16	4.700,00 ₺
IBHB6 350	3x50+16	4.700,00 ₺
IBHB6 370	3x70+16	4.800,00 ₺
IBHB6 395	3x95+16	4.800,00 ₺
IBHB6 3120	3x120+16	5.050,00 ₺
IBHB6 3150	3x150+25	5.050,00 ₺
IBHB6 3185	3x185+25	5.500,00 ₺
IBHB6 3240	3x240+25	5.500,00 ₺
IBHB6 3300	3x300+25	6.600,00 ₺
IBHB6 3400	3x400+35	6.600,00 ₺

H
A
R
I
C
I

KOD CODE	KABLO KESİTİ CROSS SECTION	FİYAT PRICE
IBHB10 325	3x25+16	4.700,00 ₺
IBHB10 335	3x35+16	4.700,00 ₺
IBHB10 350	3x50+16	4.700,00 ₺
IBHB10 370	3x70+16	4.800,00 ₺
IBHB10 395	3x95+16	4.800,00 ₺
IBHB10 3120	3x120+16	5.050,00 ₺
IBHB10 3150	3x150+25	5.050,00 ₺
IBHB10 3185	3x185+25	5.500,00 ₺
IBHB10 3240	3x240+25	5.500,00 ₺
IBHB10 3300	3x300+25	6.600,00 ₺
IBHB10 3400	3x400+35	6.600,00 ₺



KOD CODE	KABLO KESİTİ CROSS SECTION	FİYAT PRICE
IBHB15 325	3x25+16	4.700,00 ₺
IBHB15 335	3x35+16	4.700,00 ₺
IBHB15 350	3x50+16	4.700,00 ₺
IBHB15 370	3x70+16	4.800,00 ₺
IBHB15 395	3x95+16	4.800,00 ₺
IBHB15 3120	3x120+16	5.050,00 ₺
IBHB15 3150	3x150+25	5.050,00 ₺
IBHB15 3185	3x185+25	5.500,00 ₺
IBHB15 3240	3x240+25	5.500,00 ₺
IBHB15 3300	3x300+25	6.600,00 ₺
IBHB15 3400	3x400+35	6.600,00 ₺

H
A
R
I
C
I

KOD CODE	KABLO KESİTİ CROSS SECTION	FİYAT PRICE
IBHB36 325	3x25+16	5.300,00 ₺
IBHB36 335	3x35+16	5.300,00 ₺
IBHB36 350	3x50+16	5.400,00 ₺
IBHB36 370	3x70+16	5.400,00 ₺
IBHB36 395	3x95+16	5.400,00 ₺
IBHB36 3120	3x120+16	5.700,00 ₺
IBHB36 3150	3x150+25	5.700,00 ₺
IBHB36 3185	3x185+25	6.700,00 ₺
IBHB36 3240	3x240+25	6.700,00 ₺
IBHB36 3300	3x300+25	7.400,00 ₺
IBHB36 3400	3x400+35	7.400,00 ₺



3.5-6 kV



5.8-10 kV

KOD CODE	KABLO KESİTİ CROSS SECTION	FİYAT PRICE
MIBH6 125-195	1x25+16-1x95+16	1.700,00 ₺
MIBH6 1120-1150	1x120+16-1x150+25	1.800,00 ₺
MIBH6 1185-1240	1x185+25-1x240+25	2.200,00 ₺
MIBH6 1300-1400	1x300+25-1x400+35	3.100,00 ₺

KOD CODE	KABLO KESİTİ CROSS SECTION	FİYAT PRICE
MIBH10 125-195	1x25+16-1x95+16	1.700,00 ₺
MIBH10 1120-1150	1x120+16-1x150+25	1.800,00 ₺
MIBH10 1185-1240	1x185+25-1x240+25	2.200,00 ₺
MIBH10 1300-1400	1x300+25-1x400+35	3.100,00 ₺

H
A
R
I
C
İ

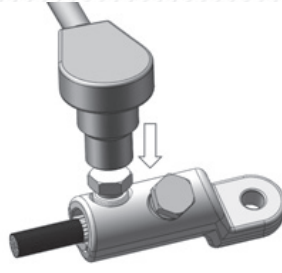
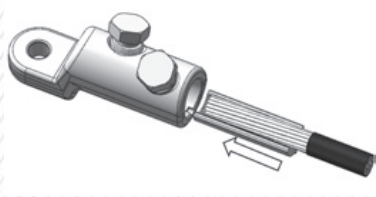

8.7-15 kV



20.8-36 kV

KOD CODE	KABLO KESİTİ CROSS SECTION	FİYAT PRICE
MIBH15 125-195	1x25+16-1x95+16	1.700,00 ₺
MIBH15 1120-1150	1x120+16-1x150+25	1.800,00 ₺
MIBH15 1185-1240	1x185+25-1x240+25	2.200,00 ₺
MIBH15 1300-1400	1x300+25-1x400+35	3.100,00 ₺

KOD CODE	KABLO KESİTİ CROSS SECTION	FİYAT PRICE
MIBH36 125-195	1x25+16-1x95+16	2.050,00 ₺
MIBH36 1120-1150	1x120+16-1x150+25	2.200,00 ₺
MIBH36 1185-1240	1x185+25-1x240+25	2.500,00 ₺
MIBH36 1300-1400	1x300+25-1x400+35	3.500,00 ₺

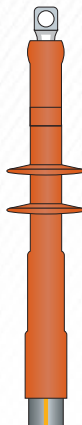

O.G. MEKANİK ÜÇ DAMARLI HARİCİ ISI BÜZÜŞMELİ KABLO BAŞLIĞI

M.V. BOLTED THREE CORES OUTDOOR HEAT SHRINKABLE CABLE TERMINATIONS



3.5-6 kV



5.8-10 kV

KOD CODE	KABLO KESİTİ CROSS SECTION	FİYAT PRICE
MIBH6 325-395	3x25+16-3x95+16	5.100,00 ₺
MIBH6 3120-3150	3x120+16-3x150+25	5.350,00 ₺
MIBH6 3185-3240	3x185+25-3x240+25	6.400,00 ₺
MIBH6 3300-3400	3x300+25-3x400+35	7.600,00 ₺

KOD CODE	KABLO KESİTİ CROSS SECTION	FİYAT PRICE
MIBH10 325-395	3x25+16-3x95+16	5.100,00 ₺
MIBH10 3120-3150	3x120+16-3x150+25	5.350,00 ₺
MIBH10 3185-3240	3x185+25-3x240+25	6.400,00 ₺
MIBH10 3300-3400	3x300+25-3x400+35	7.600,00 ₺

HARİCİ

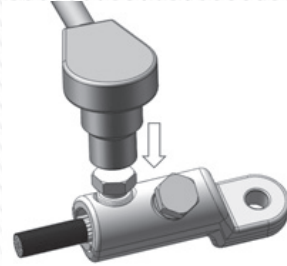
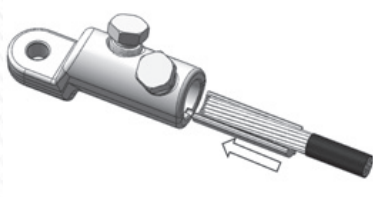

8.7-15 kV



20.8-36 kV

KOD CODE	KABLO KESİTİ CROSS SECTION	FİYAT PRICE
MIBH15 325-395	3x25+16-3x95+16	5.100,00 ₺
MIBH15 3120-3150	3x120+16-3x150+25	5.350,00 ₺
MIBH15 3185-3240	3x185+25-3x240+25	6.400,00 ₺
MIBH15 3300-3400	3x300+25-3x400+35	7.600,00 ₺

KOD CODE	KABLO KESİTİ CROSS SECTION	FİYAT PRICE
MIBH36 325-395	3x25+16-3x95+16	5.500,00 ₺
MIBH36 3120-3150	3x120+16-3x150+25	5.900,00 ₺
MIBH36 3185-3240	3x185+25-3x240+25	6.900,00 ₺
MIBH36 3300-3400	3x300+25-3x400+35	7.900,00 ₺

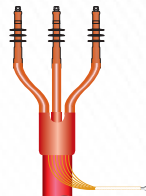

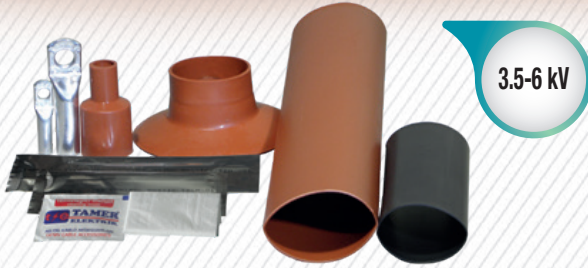

3.5-6 kV



5.8-10 kV

KOD CODE	KABLO KESİTİ CROSS SECTION	KOLİ ADETİ UNIT / BOX	FIYAT PRICE
IBD6 125	1x25+16	21	880,00 ₺
IBD6 135	1x35+16	21	880,00 ₺
IBD6 150	1x50+16	21	880,00 ₺
IBD6 170	1x70+16	21	890,00 ₺
IBD6 195	1x95+16	21	890,00 ₺
IBD6 1120	1x120+16	21	990,00 ₺
IBD6 1150	1x150+25	21	990,00 ₺
IBD6 1185	1x185+25	21	1.020,00 ₺
IBD6 1240	1x240+25	21	1.020,00 ₺
IBD6 1300	1x300+25	21	1.150,00 ₺
IBD6 1400	1x400+35	21	1.350,00 ₺
IBD6 1500	1x500+35	21	1.900,00 ₺
IBD6 1630	1x630+35	21	2.750,00 ₺

KOD CODE	KABLO KESİTİ CROSS SECTION	KOLİ ADETİ UNIT / BOX	FIYAT PRICE
IBD10 125	1x25+16	21	880,00 ₺
IBD10 135	1x35+16	21	880,00 ₺
IBD10 150	1x50+16	21	880,00 ₺
IBD10 170	1x70+16	21	890,00 ₺
IBD10 195	1x95+16	21	890,00 ₺
IBD10 1120	1x120+16	21	990,00 ₺
IBD10 1150	1x150+25	21	990,00 ₺
IBD10 1185	1x185+25	21	1.020,00 ₺
IBD10 1240	1x240+25	21	1.020,00 ₺
IBD10 1300	1x300+25	21	1.150,00 ₺
IBD10 1400	1x400+35	21	1.350,00 ₺
IBD10 1500	1x500+35	21	1.900,00 ₺
IBD10 1630	1x630+35	21	2.750,00 ₺

DAHİLİ

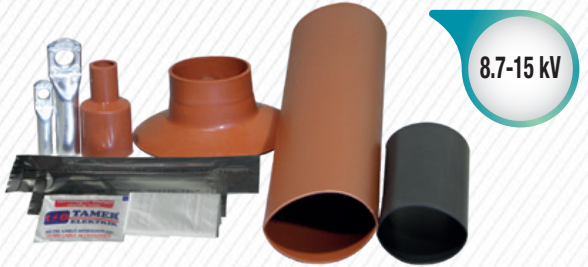

8.7-15 kV



20.8-36 kV

KOD CODE	KABLO KESİTİ CROSS SECTION	KOLİ ADETİ UNIT / BOX	FIYAT PRICE
IBD15 125	1x25+16	21	880,00 ₺
IBD15 135	1x35+16	21	880,00 ₺
IBD15 150	1x50+16	21	880,00 ₺
IBD15 170	1x70+16	21	890,00 ₺
IBD15 195	1x95+16	21	890,00 ₺
IBD15 1120	1x120+16	21	990,00 ₺
IBD15 1150	1x150+25	21	990,00 ₺
IBD15 1185	1x185+25	21	1.020,00 ₺
IBD15 1240	1x240+25	21	1.020,00 ₺
IBD15 1300	1x300+25	21	1.150,00 ₺
IBD15 1400	1x400+35	21	1.350,00 ₺
IBD15 1500	1x500+35	21	1.900,00 ₺
IBD15 1630	1x630+35	21	2.750,00 ₺

KOD CODE	KABLO KESİTİ CROSS SECTION	KOLİ ADETİ UNIT / BOX	FIYAT PRICE
IBD36 125	1x25+16	21	1.110,00 ₺
IBD36 135	1x35+16	21	1.110,00 ₺
IBD36 150	1x50+16	21	1.110,00 ₺
IBD36 170	1x70+16	21	1.130,00 ₺
IBD36 195	1x95+16	21	1.130,00 ₺
IBD36 1120	1x120+16	21	1.310,00 ₺
IBD36 1150	1x150+25	21	1.310,00 ₺
IBD36 1185	1x185+25	21	1.340,00 ₺
IBD36 1240	1x240+25	21	1.340,00 ₺
IBD36 1300	1x300+25	21	1.470,00 ₺
IBD36 1400	1x400+35	21	1.670,00 ₺
IBD36 1500	1x500+35	21	2.400,00 ₺
IBD36 1630	1x630+35	21	3.300,00 ₺

DAHİLİ



O.G. BAKIR ÜÇ DAMARLI DAHİLİ ISI BÜZÜŞMELİ KABLO BAŞLIKLARI

M.V. COPPER THREE CORES INDOOR HEAT SHRINKABLE CABLE TERMINATIONS



3.5-6 kV



5.8-10 kV

KOD CODE	KABLO KESİTİ CROSS SECTION	FİYAT PRICE
IBD6 325	3x25+16	3.600,00 ₺
IBD6 335	3x35+16	3.600,00 ₺
IBD6 350	3x50+16	3.600,00 ₺
IBD6 370	3x70+16	3.610,00 ₺
IBD6 395	3x95+16	3.610,00 ₺
IBD6 3120	3x120+16	4.000,00 ₺
IBD6 3150	3x150+25	4.000,00 ₺
IBD6 3185	3x185+25	4.100,00 ₺
IBD6 3240	3x240+25	4.100,00 ₺
IBD6 3300	3x300+25	4.300,00 ₺
IBD6 3400	3x400+35	4.750,00 ₺

DAHİLİ

KOD CODE	KABLO KESİTİ CROSS SECTION	FİYAT PRICE
IBD10 325	3x25+16	3.600,00 ₺
IBD10 335	3x35+16	3.600,00 ₺
IBD10 350	3x50+16	3.600,00 ₺
IBD10 370	3x70+16	3.610,00 ₺
IBD10 395	3x95+16	3.610,00 ₺
IBD10 3120	3x120+16	4.000,00 ₺
IBD10 3150	3x150+25	4.000,00 ₺
IBD10 3185	3x185+25	4.100,00 ₺
IBD10 3240	3x240+25	4.100,00 ₺
IBD10 3300	3x300+25	4.300,00 ₺
IBD10 3400	3x400+35	4.750,00 ₺



8.7-15 kV

20.8-36 kV

KOD CODE	KABLO KESİTİ CROSS SECTION	FİYAT PRICE
IBD15 325	3x25+16	3.600,00 ₺
IBD15 335	3x35+16	3.600,00 ₺
IBD15 350	3x50+16	3.600,00 ₺
IBD15 370	3x70+16	3.610,00 ₺
IBD15 395	3x95+16	3.610,00 ₺
IBD15 3120	3x120+16	4.000,00 ₺
IBD15 3150	3x150+25	4.000,00 ₺
IBD15 3185	3x185+25	4.100,00 ₺
IBD15 3240	3x240+25	4.100,00 ₺
IBD15 3300	3x300+25	4.300,00 ₺
IBD15 3400	3x400+35	4.750,00 ₺

DAHİLİ

KOD CODE	KABLO KESİTİ CROSS SECTION	FİYAT PRICE
IBD36 325	3x25+16	4.910,00 ₺
IBD36 335	3x35+16	4.910,00 ₺
IBD36 350	3x50+16	4.910,00 ₺
IBD36 370	3x70+16	4.980,00 ₺
IBD36 395	3x95+16	4.980,00 ₺
IBD36 3120	3x120+16	5.250,00 ₺
IBD36 3150	3x150+25	5.250,00 ₺
IBD36 3185	3x185+25	5.800,00 ₺
IBD36 3240	3x240+25	5.800,00 ₺
IBD36 3300	3x300+25	6.000,00 ₺
IBD36 3400	3x400+35	6.450,00 ₺



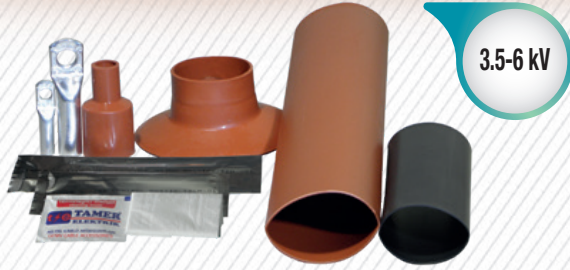

KOD CODE	KABLO KESİTİ CROSS SECTION	KOLİ ADETİ UNIT / BOX	FIYAT PRICE
IBDA6 125	1x25+16	21	870,00 ₺
IBDA6 135	1x35+16	21	870,00 ₺
IBDA6 150	1x50+16	21	870,00 ₺
IBDA6 170	1x70+16	21	880,00 ₺
IBDA6 195	1x95+16	21	880,00 ₺
IBDA6 1120	1x120+16	21	970,00 ₺
IBDA6 1150	1x150+25	21	970,00 ₺
IBDA6 1185	1x185+25	21	1.000,00 ₺
IBDA6 1240	1x240+25	21	1.000,00 ₺
IBDA6 1300	1x300+25	21	1.130,00 ₺
IBDA6 1400	1x400+35	21	1.330,00 ₺
IBDA6 1500	1x500+35	21	1.880,00 ₺
IBDA6 1630	1x630+35	21	2.730,00 ₺

KOD CODE	KABLO KESİTİ CROSS SECTION	KOLİ ADETİ UNIT / BOX	FIYAT PRICE
IBDA10 125	1x25+16	21	870,00 ₺
IBDA10 135	1x35+16	21	870,00 ₺
IBDA10 150	1x50+16	21	870,00 ₺
IBDA10 170	1x70+16	21	880,00 ₺
IBDA10 195	1x95+16	21	880,00 ₺
IBDA10 1120	1x120+16	21	970,00 ₺
IBDA10 1150	1x150+25	21	970,00 ₺
IBDA10 1185	1x185+25	21	1.000,00 ₺
IBDA10 1240	1x240+25	21	1.000,00 ₺
IBDA10 1300	1x300+25	21	1.130,00 ₺
IBDA10 1400	1x400+35	21	1.330,00 ₺
IBDA10 1500	1x500+35	21	1.880,00 ₺
IBDA10 1630	1x630+35	21	2.730,00 ₺

DAHİLİ

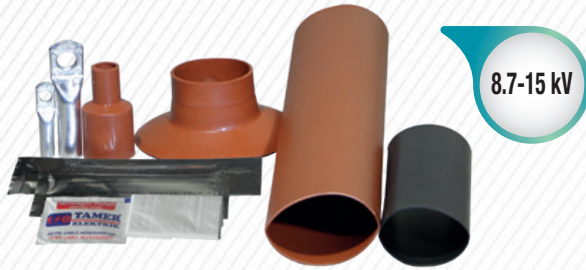

KOD CODE	KABLO KESİTİ CROSS SECTION	KOLİ ADETİ UNIT / BOX	FIYAT PRICE
IBDA15 125	1x25+16	21	870,00 ₺
IBDA15 135	1x35+16	21	870,00 ₺
IBDA15 150	1x50+16	21	870,00 ₺
IBDA15 170	1x70+16	21	880,00 ₺
IBDA15 195	1x95+16	21	880,00 ₺
IBDA15 1120	1x120+16	21	970,00 ₺
IBDA15 1150	1x150+25	21	970,00 ₺
IBDA15 1185	1x185+25	21	1.000,00 ₺
IBDA15 1240	1x240+25	21	1.000,00 ₺
IBDA15 1300	1x300+25	21	1.130,00 ₺
IBDA15 1400	1x400+35	21	1.330,00 ₺
IBDA15 1500	1x500+35	21	1.880,00 ₺
IBDA15 1630	1x630+35	21	2.730,00 ₺

KOD CODE	KABLO KESİTİ CROSS SECTION	KOLİ ADETİ UNIT / BOX	FIYAT PRICE
IBDA36 125	1x25+16	21	1.100,00 ₺
IBDA36 135	1x35+16	21	1.100,00 ₺
IBDA36 150	1x50+16	21	1.100,00 ₺
IBDA36 170	1x70+16	21	1.120,00 ₺
IBDA36 195	1x95+16	21	1.120,00 ₺
IBDA36 1120	1x120+16	21	1.290,00 ₺
IBDA36 1150	1x150+25	21	1.290,00 ₺
IBDA36 1185	1x185+25	21	1.320,00 ₺
IBDA36 1240	1x240+25	21	1.320,00 ₺
IBDA36 1300	1x300+25	21	1.450,00 ₺
IBDA36 1400	1x400+35	21	1.650,00 ₺
IBDA36 1500	1x500+35	21	2.380,00 ₺
IBDA36 1630	1x630+35	21	3.280,00 ₺

DAHİLİ

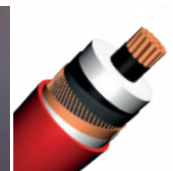

O.G. ALÜMİNYUM ÜÇ DAMARLI DAHİLİ ISI BÜZÜŞMELİ KABLO BAŞLIKLARI

M.V. ALUMINUM THREE CORES INDOOR HEAT SHRINKABLE CABLE TERMINATIONS



3.5-6 kV



5.8-10 kV

KOD CODE	KABLO KESİTİ CROSS SECTION	FİYAT PRICE
IBDA6 325	3x25+16	3.590,00 ₺
IBDA6 335	3x35+16	3.590,00 ₺
IBDA6 350	3x50+16	3.590,00 ₺
IBDA6 370	3x70+16	3.600,00 ₺
IBDA6 395	3x95+16	3.600,00 ₺
IBDA6 3120	3x120+16	3.980,00 ₺
IBDA6 3150	3x150+25	3.980,00 ₺
IBDA6 3185	3x185+25	4.080,00 ₺
IBDA6 3240	3x240+25	4.080,00 ₺
IBDA6 3300	3x300+25	4.280,00 ₺
IBDA6 3400	3x400+35	4.730,00 ₺

DAHİLİ

KOD CODE	KABLO KESİTİ CROSS SECTION	FİYAT PRICE
IBDA10 325	3x25+16	3.590,00 ₺
IBDA10 335	3x35+16	3.590,00 ₺
IBDA10 350	3x50+16	3.590,00 ₺
IBDA10 370	3x70+16	3.600,00 ₺
IBDA10 395	3x95+16	3.600,00 ₺
IBDA10 3120	3x120+16	3.980,00 ₺
IBDA10 3150	3x150+25	3.980,00 ₺
IBDA10 3185	3x185+25	4.080,00 ₺
IBDA10 3240	3x240+25	4.080,00 ₺
IBDA10 3300	3x300+25	4.280,00 ₺
IBDA10 3400	3x400+35	4.730,00 ₺



8.7-15 kV

20.8-36 kV



KOD CODE	KABLO KESİTİ CROSS SECTION	FİYAT PRICE
IBDA15 325	3x25+16	3.590,00 ₺
IBDA15 335	3x35+16	3.590,00 ₺
IBDA15 350	3x50+16	3.590,00 ₺
IBDA15 370	3x70+16	3.600,00 ₺
IBDA15 395	3x95+16	3.600,00 ₺
IBDA15 3120	3x120+16	3.980,00 ₺
IBDA15 3150	3x150+25	3.980,00 ₺
IBDA15 3185	3x185+25	4.080,00 ₺
IBDA15 3240	3x240+25	4.080,00 ₺
IBDA15 3300	3x300+25	4.280,00 ₺
IBDA15 3400	3x400+35	4.730,00 ₺

DAHİLİ

KOD CODE	KABLO KESİTİ CROSS SECTION	FİYAT PRICE
IBDA36 325	3x25+16	4.900,00 ₺
IBDA36 335	3x35+16	4.900,00 ₺
IBDA36 350	3x50+16	4.900,00 ₺
IBDA36 370	3x70+16	4.970,00 ₺
IBDA36 395	3x95+16	4.970,00 ₺
IBDA36 3120	3x120+16	5.240,00 ₺
IBDA36 3150	3x150+25	5.240,00 ₺
IBDA36 3185	3x185+25	5.780,00 ₺
IBDA36 3240	3x240+25	5.780,00 ₺
IBDA36 3300	3x300+25	5.980,00 ₺
IBDA36 3400	3x400+35	6.430,00 ₺



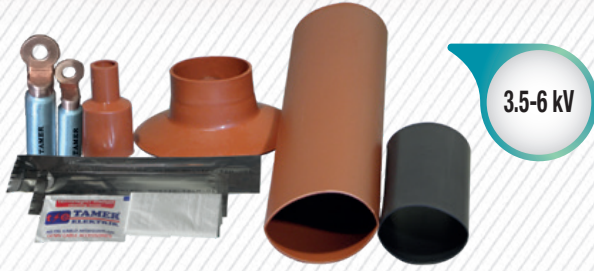

3.5-6 kV

KOD CODE	KABLO KESİTİ CROSS SECTION	KOLİ ADETİ UNIT / BOX	FİYAT PRICE
IBDB6 125	1x25+16	21	1.170,00 ₺
IBDB6 135	1x35+16	21	1.170,00 ₺
IBDB6 150	1x50+16	21	1.170,00 ₺
IBDB6 170	1x70+16	21	1.220,00 ₺
IBDB6 195	1x95+16	21	1.220,00 ₺
IBDB6 1120	1x120+16	21	1.310,00 ₺
IBDB6 1150	1x150+25	21	1.310,00 ₺
IBDB6 1185	1x185+25	21	1.750,00 ₺
IBDB6 1240	1x240+25	21	1.750,00 ₺
IBDB6 1300	1x300+25	21	2.100,00 ₺
IBDB6 1400	1x400+35	21	2.100,00 ₺



5.8-10 kV

KOD CODE	KABLO KESİTİ CROSS SECTION	KOLİ ADETİ UNIT / BOX	FİYAT PRICE
IBDB10 125	1x25+16	21	1.170,00 ₺
IBDB10 135	1x35+16	21	1.170,00 ₺
IBDB10 150	1x50+16	21	1.170,00 ₺
IBDB10 170	1x70+16	21	1.220,00 ₺
IBDB10 195	1x95+16	21	1.220,00 ₺
IBDB10 1120	1x120+16	21	1.310,00 ₺
IBDB10 1150	1x150+25	21	1.310,00 ₺
IBDB10 1185	1x185+25	21	1.750,00 ₺
IBDB10 1240	1x240+25	21	1.750,00 ₺
IBDB10 1300	1x300+25	21	2.100,00 ₺
IBDB10 1400	1x400+35	21	2.100,00 ₺

DAHİLİ



8.7-15 kV

KOD CODE	KABLO KESİTİ CROSS SECTION	KOLİ ADETİ UNIT / BOX	FİYAT PRICE
IBDB15 125	1x25+16	21	1.170,00 ₺
IBDB15 135	1x35+16	21	1.170,00 ₺
IBDB15 150	1x50+16	21	1.170,00 ₺
IBDB15 170	1x70+16	21	1.220,00 ₺
IBDB15 195	1x95+16	21	1.220,00 ₺
IBDB15 1120	1x120+16	21	1.310,00 ₺
IBDB15 1150	1x150+25	21	1.310,00 ₺
IBDB15 1185	1x185+25	21	1.750,00 ₺
IBDB15 1240	1x240+25	21	1.750,00 ₺
IBDB15 1300	1x300+25	21	2.100,00 ₺
IBDB15 1400	1x400+35	21	2.100,00 ₺



20.8-36 kV

KOD CODE	KABLO KESİTİ CROSS SECTION	KOLİ ADETİ UNIT / BOX	FİYAT PRICE
IBDB36 125	1x25+16	21	1.350,00 ₺
IBDB36 135	1x35+16	21	1.350,00 ₺
IBDB36 150	1x50+16	21	1.350,00 ₺
IBDB36 170	1x70+16	21	1.400,00 ₺
IBDB36 195	1x95+16	21	1.400,00 ₺
IBDB36 1120	1x120+16	21	1.550,00 ₺
IBDB36 1150	1x150+25	21	1.550,00 ₺
IBDB36 1185	1x185+25	21	1.750,00 ₺
IBDB36 1240	1x240+25	21	1.750,00 ₺
IBDB36 1300	1x300+25	21	2.350,00 ₺
IBDB36 1400	1x400+35	21	2.350,00 ₺

DAHİLİ

O.G. BİMETAL 3 DAMARLI DAHİLİ ISI BÜZÜŞMELİ KABLO BAŞLIKLARI

M.V. BIMETALLIC 3 CORE INDOOR HEAT SHRINKABLE CABLE TERMINATIONS



3.5-6 kV

KOD CODE	KABLO KESİTİ CROSS SECTION	FİYAT PRICE
IBDB6 325	3x25+16	3.800,00 ₺
IBDB6 335	3x35+16	3.800,00 ₺
IBDB6 350	3x50+16	3.800,00 ₺
IBDB6 370	3x70+16	3.900,00 ₺
IBDB6 395	3x95+16	3.900,00 ₺
IBDB6 3120	3x120+16	4.000,00 ₺
IBDB6 3150	3x150+25	4.000,00 ₺
IBDB6 3185	3x185+25	5.000,00 ₺
IBDB6 3240	3x240+25	5.000,00 ₺
IBDB6 3300	3x300+25	5.900,00 ₺
IBDB6 3400	3x400+35	5.900,00 ₺

DAHİLİ



5.8-10 kV

KOD CODE	KABLO KESİTİ CROSS SECTION	FİYAT PRICE
IBDB10 325	3x25+16	3.800,00 ₺
IBDB10 335	3x35+16	3.800,00 ₺
IBDB10 350	3x50+16	3.800,00 ₺
IBDB10 370	3x70+16	3.900,00 ₺
IBDB10 395	3x95+16	3.900,00 ₺
IBDB10 3120	3x120+16	4.000,00 ₺
IBDB10 3150	3x150+25	4.000,00 ₺
IBDB10 3185	3x185+25	5.000,00 ₺
IBDB10 3240	3x240+25	5.000,00 ₺
IBDB10 3300	3x300+25	5.900,00 ₺
IBDB10 3400	3x400+35	5.900,00 ₺



8.7-15 kV

KOD CODE	KABLO KESİTİ CROSS SECTION	FİYAT PRICE
IBDB15 325	3x25+16	3.800,00 ₺
IBDB15 335	3x35+16	3.800,00 ₺
IBDB15 350	3x50+16	3.800,00 ₺
IBDB15 370	3x70+16	3.900,00 ₺
IBDB15 395	3x95+16	3.900,00 ₺
IBDB15 3120	3x120+16	4.000,00 ₺
IBDB15 3150	3x150+25	4.000,00 ₺
IBDB15 3185	3x185+25	5.000,00 ₺
IBDB15 3240	3x240+25	5.000,00 ₺
IBDB15 3300	3x300+25	5.900,00 ₺
IBDB15 3400	3x400+35	5.900,00 ₺

DAHİLİ



20.8-36 kV

KOD CODE	KABLO KESİTİ CROSS SECTION	FİYAT PRICE
IBDB36 325	3x25+16	5.000,00 ₺
IBDB36 335	3x35+16	5.000,00 ₺
IBDB36 350	3x50+16	5.000,00 ₺
IBDB36 370	3x70+16	5.100,00 ₺
IBDB36 395	3x95+16	5.100,00 ₺
IBDB36 3120	3x120+16	5.400,00 ₺
IBDB36 3150	3x150+25	5.400,00 ₺
IBDB36 3185	3x185+25	6.300,00 ₺
IBDB36 3240	3x240+25	6.300,00 ₺
IBDB36 3300	3x300+25	7.000,00 ₺
IBDB36 3400	3x400+35	7.000,00 ₺



3.5-6 kV



5.8-10 kV

KOD CODE	KABLO KESİTİ CROSS SECTION	FİYAT PRICE
MIBD6 125-195	1x25+16-1x95+16	1.400,00 ₺
MIBD6 1120-1150	1x120+16-1x150+25	1.500,00 ₺
MIBD6 1185-1240	1x185+25-1x240+25	1.950,00 ₺
MIBD6 1300-1400	1x300+25-1x400+35	2.700,00 ₺

DAHİLİ

KOD CODE	KABLO KESİTİ CROSS SECTION	FİYAT PRICE
MIBD10 125-195	1x25+16-1x95+16	1.400,00 ₺
MIBD10 1120-1150	1x120+16-1x150+25	1.500,00 ₺
MIBD10 1185-1240	1x185+25-1x240+25	1.950,00 ₺
MIBD10 1300-1400	1x300+25-1x400+35	2.700,00 ₺

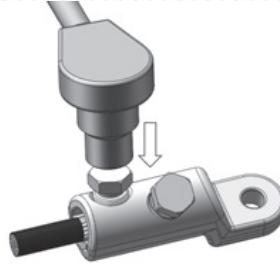
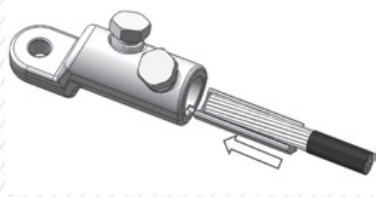

8.7-15 kV



20.8-36 kV

KOD CODE	KABLO KESİTİ CROSS SECTION	FİYAT PRICE
MIBD15 125-195	1x25+16-1x95+16	1.400,00 ₺
MIBD15 1120-1150	1x120+16-1x150+25	1.500,00 ₺
MIBD15 1185-1240	1x185+25-1x240+25	1.950,00 ₺
MIBD15 1300-1400	1x300+25-1x400+35	2.700,00 ₺

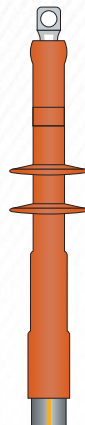

KOD CODE	KABLO KESİTİ CROSS SECTION	FİYAT PRICE
MIBD36 125-195	1x25+16-1x95+16	1.750,00 ₺
MIBD36 1120-1150	1x120+16-1x150+25	1.900,00 ₺
MIBD36 1185-1240	1x185+25-1x240+25	2.200,00 ₺
MIBD36 1300-1400	1x300+25-1x400+35	2.900,00 ₺



O.G. MEKANİK ÜÇ DAMARLI DAHİLİ ISI BÜZÜŞMELİ KABLO BAŞLIKLARI

M.V. BOLTED THREE CORES INDOOR HEAT SHRINKABLE CABLE TERMINATIONS



3.5-6 kV



5.8-10 kV

KOD CODE	KABLO KESİTİ CROSS SECTION	FİYAT PRICE
MIBD6 325-395	3x25+16-3x95+16	4.750,00 ₺
MIBD6 3120-3150	3x120+16-3x150+25	5.000,00 ₺
MIBD6 3185-3240	3x185+25-3x240+25	6.000,00 ₺
MIBD6 3300-3400	3x300+25-3x400+35	7.350,00 ₺

DAHİLİ

KOD CODE	KABLO KESİTİ CROSS SECTION	FİYAT PRICE
MIBD10 325-395	3x25+16-3x95+16	4.750,00 ₺
MIBD10 3120-3150	3x120+16-3x150+25	5.000,00 ₺
MIBD10 3185-3240	3x185+25-3x240+25	6.000,00 ₺
MIBD10 3300-3400	3x300+25-3x400+35	7.350,00 ₺

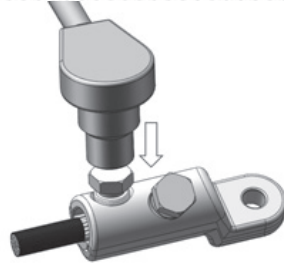
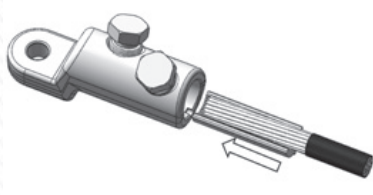

8.7-15 kV



20.8-36 kV

KOD CODE	KABLO KESİTİ CROSS SECTION	FİYAT PRICE
MIBD15 325-395	3x25+16-3x95+16	4.750,00 ₺
MIBD15 3120-3150	3x120+16-3x150+25	5.000,00 ₺
MIBD15 3185-3240	3x185+25-3x240+25	6.000,00 ₺
MIBD15 3300-3400	3x300+25-3x400+35	7.350,00 ₺

KOD CODE	KABLO KESİTİ CROSS SECTION	FİYAT PRICE
MIBD36 325-395	3x25+16-3x95+16	5.150,00 ₺
MIBD36 3120-3150	3x120+16-3x150+25	5.550,00 ₺
MIBD36 3185-3240	3x185+25-3x240+25	6.500,00 ₺
MIBD36 3300-3400	3x300+25-3x400+35	7.650,00 ₺

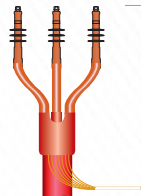



KOD CODE	KABLO KESİTİ CROSS SECTION	FİYAT PRICE
SH6 125	1x25+16	1.050,00 ₺
SH6 135	1x35+16	1.050,00 ₺
SH6 150	1x50+16	1.050,00 ₺
SH6 170	1x70+16	1.120,00 ₺
SH6 195	1x95+16	1.120,00 ₺
SH6 1120	1x120+16	1.190,00 ₺
SH6 1150	1x150+25	1.190,00 ₺
SH6 1185	1x185+25	1.250,00 ₺
SH6 1240	1x240+25	1.250,00 ₺



KOD CODE	KABLO KESİTİ CROSS SECTION	FİYAT PRICE
SH10 125	1x25+16	1.050,00 ₺
SH10 135	1x35+16	1.050,00 ₺
SH10 150	1x50+16	1.050,00 ₺
SH10 170	1x70+16	1.120,00 ₺
SH10 195	1x95+16	1.120,00 ₺
SH10 1120	1x120+16	1.190,00 ₺
SH10 1150	1x150+25	1.190,00 ₺
SH10 1185	1x185+25	1.250,00 ₺
SH10 1240	1x240+25	1.250,00 ₺

H
A
R
İ
C
İ



KOD CODE	KABLO KESİTİ CROSS SECTION	FİYAT PRICE
SH15 125	1x25+16	1.200,00 ₺
SH15 135	1x35+16	1.200,00 ₺
SH15 150	1x50+16	1.200,00 ₺
SH15 170	1x70+16	1.300,00 ₺
SH15 195	1x95+16	1.300,00 ₺
SH15 1120	1x120+16	1.400,00 ₺
SH15 1150	1x150+25	1.400,00 ₺
SH15 1185	1x185+25	1.550,00 ₺
SH15 1240	1x240+25	1.550,00 ₺



KOD CODE	KABLO KESİTİ CROSS SECTION	FİYAT PRICE
SH36 125	1x25+16	1.500,00 ₺
SH36 135	1x35+16	1.500,00 ₺
SH36 150	1x50+16	1.700,00 ₺
SH36 170	1x70+16	1.700,00 ₺
SH36 195	1x95+16	1.800,00 ₺
SH36 1120	1x120+16	1.800,00 ₺
SH36 1150	1x150+25	1.900,00 ₺
SH36 1185	1x185+25	1.900,00 ₺
SH36 1240	1x240+25	2.050,00 ₺

H
A
R
İ
C
İ

* Alüminyum iletkenli üretim yapılıdır.
* Production of aluminium conductors are made

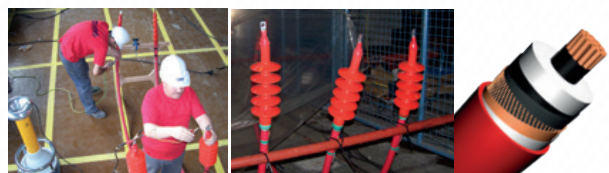

O.G. ÜÇ DAMARLI HARİCİ SİLİKON KABLO BAŞLIKLARI

M.V. THREE CORES OUTDOOR SILICONE CABLE TERMINATIONS



3.5-6 kV



5.8-10 kV

KOD CODE	KABLO KESİTİ CROSS SECTION	FİYAT PRICE
SH6 325	3x25+16	4.000,00 ₺
SH6 335	3x35+16	4.000,00 ₺
SH6 350	3x50+16	4.000,00 ₺
SH6 370	3x70+16	4.150,00 ₺
SH6 395	3x95+16	4.150,00 ₺
SH6 3120	3x120+16	4.400,00 ₺
SH6 3150	3x150+25	4.400,00 ₺
SH6 3185	3x185+25	4.500,00 ₺
SH6 3240	3x240+25	4.600,00 ₺

H
A
R
I
C
I

KOD CODE	KABLO KESİTİ CROSS SECTION	FİYAT PRICE
SH10 325	3x25+16	4.000,00 ₺
SH10 335	3x35+16	4.000,00 ₺
SH10 350	3x50+16	4.000,00 ₺
SH10 370	3x70+16	4.150,00 ₺
SH10 395	3x95+16	4.150,00 ₺
SH10 3120	3x120+16	4.400,00 ₺
SH10 3150	3x150+25	4.400,00 ₺
SH10 3185	3x185+25	4.500,00 ₺
SH10 3240	3x240+25	4.600,00 ₺



8.7-15 kV

20.8-36 kV



KOD CODE	KABLO KESİTİ CROSS SECTION	FİYAT PRICE
SH15 325	3x25+16	4.200,00 ₺
SH15 335	3x35+16	4.200,00 ₺
SH15 350	3x50+16	4.200,00 ₺
SH15 370	3x70+16	4.350,00 ₺
SH15 395	3x95+16	4.350,00 ₺
SH15 3120	3x120+16	4.600,00 ₺
SH15 3150	3x150+25	4.600,00 ₺
SH15 3185	3x185+25	4.700,00 ₺
SH15 3240	3x240+25	4.800,00 ₺

H
A
R
I
C
I

KOD CODE	KABLO KESİTİ CROSS SECTION	FİYAT PRICE
SH36 325	3x25+16	5.700,00 ₺
SH36 335	3x35+16	5.700,00 ₺
SH36 350	3x50+16	5.700,00 ₺
SH36 370	3x70+16	5.850,00 ₺
SH36 395	3x95+16	5.850,00 ₺
SH36 3120	3x120+16	6.000,00 ₺
SH36 3150	3x150+25	6.000,00 ₺
SH36 3185	3x185+25	6.100,00 ₺
SH36 3240	3x240+25	6.200,00 ₺





3.5-6 kV

KOD CODE	KABLO KESİTİ CROSS SECTION	FİYAT PRICE
SD6 125	1x25+16	880,00 ₺
SD6 135	1x35+16	880,00 ₺
SD6 150	1x50+16	880,00 ₺
SD6 170	1x70+16	940,00 ₺
SD6 195	1x95+16	940,00 ₺
SD6 1120	1x120+16	1.000,00 ₺
SD6 1150	1x150+25	1.000,00 ₺
SD6 1185	1x185+25	1.050,00 ₺
SD6 1240	1x240+25	1.050,00 ₺



5.8-10 kV

KOD CODE	KABLO KESİTİ CROSS SECTION	FİYAT PRICE
SD10 125	1x25+16	880,00 ₺
SD10 135	1x35+16	880,00 ₺
SD10 150	1x50+16	880,00 ₺
SD10 170	1x70+16	940,00 ₺
SD10 195	1x95+16	940,00 ₺
SD10 1120	1x120+16	1.000,00 ₺
SD10 1150	1x150+25	1.000,00 ₺
SD10 1185	1x185+25	1.050,00 ₺
SD10 1240	1x240+25	1.050,00 ₺

DAHİLİ



8.7-15 kV

KOD CODE	KABLO KESİTİ CROSS SECTION	FİYAT PRICE
SD15 125	1x25+16	980,00 ₺
SD15 135	1x35+16	980,00 ₺
SD15 150	1x50+16	980,00 ₺
SD15 170	1x70+16	1.050,00 ₺
SD15 195	1x95+16	1.050,00 ₺
SD15 1120	1x120+16	1.150,00 ₺
SD15 1150	1x150+25	1.150,00 ₺
SD15 1185	1x185+25	1.250,00 ₺
SD15 1240	1x240+25	1.250,00 ₺



20.8-36 kV

KOD CODE	KABLO KESİTİ CROSS SECTION	FİYAT PRICE
SD36 125	1x25+16	1.100,00 ₺
SD36 135	1x35+16	1.100,00 ₺
SD36 150	1x50+16	1.200,00 ₺
SD36 170	1x70+16	1.200,00 ₺
SD36 195	1x95+16	1.300,00 ₺
SD36 1120	1x120+16	1.300,00 ₺
SD36 1150	1x150+25	1.400,00 ₺
SD36 1185	1x185+25	1.400,00 ₺
SD36 1240	1x240+25	1.500,00 ₺

DAHİLİ

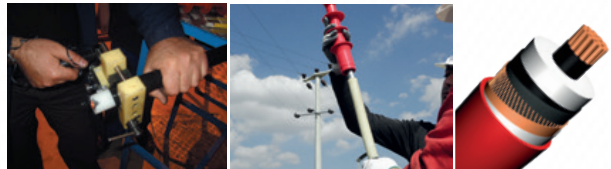

O.G. ÜÇ DAMARLI DAHİLİ SİLİKON KABLO BAŞLIKLARI

M.V. THREE CORES INDOOR SILICONE CABLE TERMINATIONS



3.5-6 kV

5.8-10 kV



KOD CODE	KABLO KESİTİ CROSS SECTION	FİYAT PRICE
SD6 325	3x25+16	3.300,00 ₺
SD6 335	3x35+16	3.300,00 ₺
SD6 350	3x50+16	3.300,00 ₺
SD6 370	3x70+16	3.350,00 ₺
SD6 395	3x95+16	3.350,00 ₺
SD6 3120	3x120+16	3.600,00 ₺
SD6 3150	3x150+25	3.600,00 ₺
SD6 3185	3x185+25	3.700,00 ₺
SD6 3240	3x240+25	3.800,00 ₺

DAHİLİ

KOD CODE	KABLO KESİTİ CROSS SECTION	FİYAT PRICE
SD10 325	3x25+16	3.300,00 ₺
SD10 335	3x35+16	3.300,00 ₺
SD10 350	3x50+16	3.300,00 ₺
SD10 370	3x70+16	3.350,00 ₺
SD10 395	3x95+16	3.350,00 ₺
SD10 3120	3x120+16	3.600,00 ₺
SD10 3150	3x150+25	3.600,00 ₺
SD10 3185	3x185+25	3.700,00 ₺
SD10 3240	3x240+25	3.800,00 ₺



8.7-15 kV



20.8-36 kV

KOD CODE	KABLO KESİTİ CROSS SECTION	FİYAT PRICE
SD15 325	3x25+16	3.500,00 ₺
SD15 335	3x35+16	3.500,00 ₺
SD15 350	3x50+16	3.500,00 ₺
SD15 370	3x70+16	3.550,00 ₺
SD15 395	3x95+16	3.550,00 ₺
SD15 3120	3x120+16	3.800,00 ₺
SD15 3150	3x150+25	3.800,00 ₺
SD15 3185	3x185+25	3.900,00 ₺
SD15 3240	3x240+25	4.000,00 ₺

DAHİLİ

KOD CODE	KABLO KESİTİ CROSS SECTION	FİYAT PRICE
SD36 325	3x25+16	4.500,00 ₺
SD36 335	3x35+16	4.500,00 ₺
SD36 350	3x50+16	4.500,00 ₺
SD36 370	3x70+16	4.650,00 ₺
SD36 395	3x95+16	4.650,00 ₺
SD36 3120	3x120+16	4.800,00 ₺
SD36 3150	3x150+25	4.800,00 ₺
SD36 3185	3x185+25	4.900,00 ₺
SD36 3240	3x240+25	5.000,00 ₺



TEK DAMARLI HARİCİ KABLO BAŞLIĞI
SINGLE CORE OUTDOOR CABLE TERMINATIONS

KOD CODE	KABLO KESİTİ CROSS SECTION	FİYAT PRICE
TSH36 135	1x35+16	1.750,00 ₺
TSH36 150	1x50+16	1.750,00 ₺
TSH36 170	1x70+16	1.750,00 ₺
TSH36 195	1x95+16	1.750,00 ₺
TSH36 1120	1x120+16	2.000,00 ₺
TSH36 1150	1x150+25	2.000,00 ₺
TSH36 1185	1x185+25	2.000,00 ₺
TSH36 1240	1x240+25	2.000,00 ₺

H
A
R
İ
C
İ



TEK DAMARLI DAHİLİ KABLO BAŞLIĞI
SINGLE CORE INDOOR CABLE TERMINATIONS

KOD CODE	KABLO KESİTİ CROSS SECTION	FİYAT PRICE
TSD36 135	1x35+16	1.580,00 ₺
TSD36 150	1x50+16	1.580,00 ₺
TSD36 170	1x70+16	1.580,00 ₺
TSD36 195	1x95+16	1.580,00 ₺
TSD36 1120	1x120+16	1.850,00 ₺
TSD36 1150	1x150+25	1.850,00 ₺
TSD36 1185	1x185+25	1.850,00 ₺
TSD36 1240	1x240+25	1.850,00 ₺

D
A
H
İ
L
İ

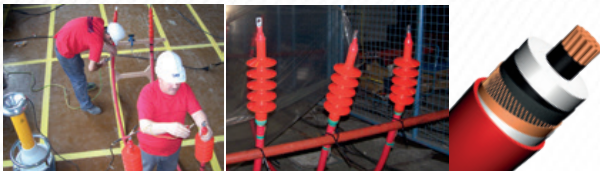

O.G. TESLA MODELİ (YEKPAE) SİLİKON KABLO BAŞLIKLARI

M.V. TESLA TYPE SILICONE CABLE TERMINATIONS

ÜÇ DAMARLI HARİCİ KABLO BAŞLIĞI THREE CORES OUTDOOR CABLE TERMINATIONS

KOD CODE	KABLO KESİTİ CROSS SECTION	FİYAT PRICE
TSH36 335	3x35+16	5.600,00 ₺
TSH36 350	3x50+16	5.600,00 ₺
TSH36 370	3x70+16	5.600,00 ₺
TSH36 395	3x95+16	5.600,00 ₺
TSH36 3120	3x120+16	6.400,00 ₺
TSH36 3150	3x150+25	6.400,00 ₺
TSH36 3185	3x185+25	6.400,00 ₺
TSH36 3240	3x240+25	6.400,00 ₺

20.8-36 kV



H
A
R
İ
C
İ

ÜÇ DAMARLI DAHİLİ KABLO BAŞLIĞI THREE CORES INDOOR CABLE TERMINATIONS

KOD CODE	KABLO KESİTİ CROSS SECTION	FİYAT PRICE
TSD36 335	3x35+16	5.100,00 ₺
TSD36 350	3x50+16	5.100,00 ₺
TSD36 370	3x70+16	5.100,00 ₺
TSD36 395	3x95+16	5.100,00 ₺
TSD36 3120	3x120+16	5.900,00 ₺
TSD36 3150	3x150+25	5.900,00 ₺
TSD36 3185	3x185+25	5.900,00 ₺
TSD36 3240	3x240+25	5.900,00 ₺

20.8-36 kV



D
A
H
İ
L
İ

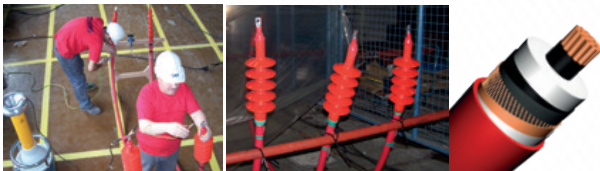

Silikon Kablo
Başlıkları

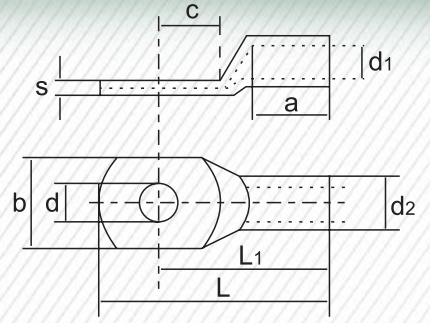
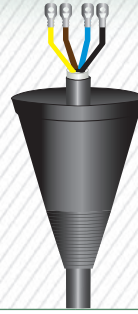

KOD CODE	KESİT CROSS SECTION	BAĞLANTI SCREW DIAMETER	KUTU / ADET UNIT / BOX	FİYAT PRICE	a (mm)	b (mm)	c (mm)	d (mm)	d1 (mm)	d2 (mm)	L (mm)	L1 (mm)	s (mm)
SKP 06	6 mm ²	M 6	1500	9,50 ₺	7,5	7,8	6,7	5,4	4,1	5,45	25,1	18,55	1,55
SKP 10	10 mm ²	M 6	1000	11,50 ₺	15	8,9	7,24	5,6	4,57	5,9	36,2	29,5	1,3
SKP 16	16 mm ²	M 8	400	16,00 ₺	20	12,9	13	8,6	6,5	8,55	51	44,2	1,8
SKP 25	25 mm ²	M 8	250	21,00 ₺	25	14,2	12	8,55	7	10	53,5	42,6	2,95
SKP 35	35 mm ²	M 10	200	31,00 ₺	25	17,1	10,5	10,5	8,8	11,48	58	46,7	2,38
SKP 50	50 mm ²	M 10	150	53,00 ₺	25	18,7	12,9	10,6	10,1	13	63,4	53,4	2,8
SKP 70	70 mm ²	M 12	100	60,00 ₺	27,8	21	12,71	13,5	11,7	14,48	71,2	55	2,88
SKP 95	95 mm ²	M 12	75	95,00 ₺	34	24,8	15,2	13,5	13,49	17,25	82,5	66	3,34
SKP 120	120 mm ²	M 12	50	140,00 ₺	33	26	15	13	14,35	18,14	83,7	67,8	3,46
SKP 150	150 mm ²	M 12	35	175,00 ₺	35	32	12,8	13	17,7	21,85	92,7	76,7	3,77
SKP 185	185 mm ²	M 16	25	230,00 ₺	39	33,6	16,7	17	18	23,1	99,3	80,1	3,8
SKP 240	240 mm ²	M 16	18	290,00 ₺	40	39,1	16,1	17	21,2	27	108	89	5,27
SKP 300	300 mm ²	M 20	14	420,00 ₺	48	43,4	20	21	24	30,12	120	100	5,87
SKP 400	400 mm ²	M 20	10	600,00 ₺	48	50	23	21	27,2	34,85	122	117,6	6,9

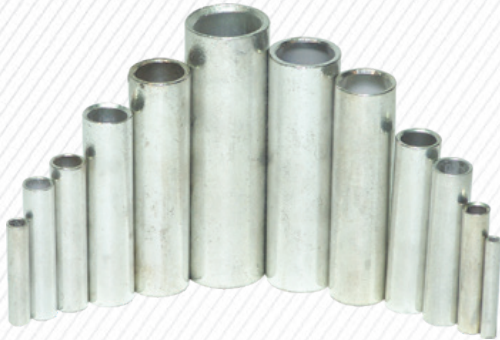

SIKMALI BAKIR EK MUFLARI

COMPRESSIVE COPPER CONNECTORS

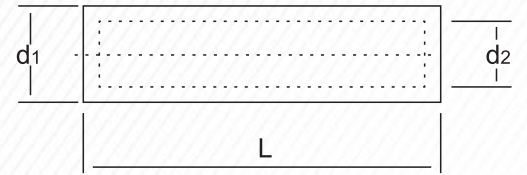

KOD CODE	KESİT CROSS SECTION	KUTU / ADET UNIT / BOX	FİYAT PRICE	L (mm)	d1 (mm)	d2 (mm)	d1-d2/2 (mm)
SEM 06	6 mm ²	1500	9,00 ₺	30,2	5,8	4,1	0,85
SEM 10	10 mm ²	1000	10,50 ₺	40,1	6,78	5,1	0,84
SEM 16	16 mm ²	400	15,50 ₺	42	8,25	6,7	0,775
SEM 25	25 mm ²	250	20,50 ₺	50	9,9	7,22	1,34
SEM 35	35 mm ²	200	30,00 ₺	52	11,5	8,5	1,35
SEM 50	50 mm ²	150	50,00 ₺	58	12,9	10	1,45
SEM 70	70 mm ²	100	57,00 ₺	61,5	14,3	11,5	1,4
SEM 95	95 mm ²	75	90,00 ₺	68	16,7	13,3	1,7
SEM 120	120 mm ²	50	130,00 ₺	70	19,4	15,5	1,95
SEM 150	150 mm ²	35	165,00 ₺	80	20,0	16	2,0
SEM 185	185 mm ²	25	205,00 ₺	84	22,9	18,6	2,15
SEM 240	240 mm ²	18	285,00 ₺	92	26,8	21,6	2,6
SEM 300	300 mm ²	14	410,00 ₺	101	30,3	24,4	2,95
SEM 400	400 mm ²	10	560,00 ₺	120	34	27	3,5
SEM 630	630 mm ²	5	1.050,00 ₺	140	43,8	34,8	4,5

SIKMALI ALÜMİNYUM KABLO PABUCU

COMPRESSIVE ALUMINIUM CABLE LUG

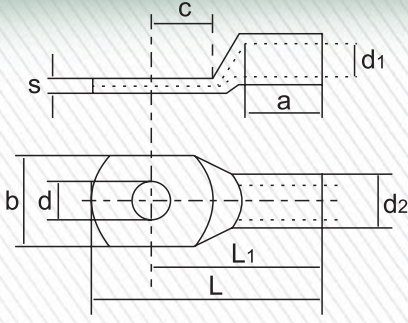

KOD CODE	KESİT CROSS SECTION	BAĞLANTI SCREW DIAMETER	KUTU / ADET UNIT / BOX	FİYAT PRICE	a (mm)	b (mm)	c (mm)	d (mm)	d1 (mm)	d2 (mm)	L (mm)	L1 (mm)	s (mm)
ASKP 16	16 mm ²	M6	400	14,60 ₺	20	13	7,5	6,5	6	10	56	48,5	4
ASKP 25	25 mm ²	M6	250	18,20 ₺	20	15	9	8,5	7	12	62	53	4,5
ASKP 35	35 mm ²	M6	200	25,00 ₺	20	19	10	10,5	8,2	14	75	63	5
ASKP 50	50 mm ²	M8	150	31,50 ₺	28	22	11,5	10,5	10	16	80	69,5	5,5
ASKP 70	70 mm ²	M8	100	40,00 ₺	28	24	12,5	10,5	12	18	95	81,5	6
ASKP 95	95 mm ²	M10	75	65,50 ₺	35	28	13,5	13	13,5	22	102	88,5	8,5
ASKP 120	120 mm ²	M10	50	81,00 ₺	35	32	16	13	16	23	112	96	6,5
ASKP 150	150 mm ²	M12	35	98,50 ₺	35	34	17,5	13	17	26	114	96,5	8
ASKP 185	185 mm ²	M12	25	117,00 ₺	40	37	19	15	18,5	28	125	106	8
ASKP 240	240 mm ²	M12	18	160,00 ₺	40	42	20	17	22	32	141,5	121,5	10,5
ASKP 300	300 mm ²	M16	8	205,00 ₺	76	46,5	31,5	17	23,5	34	142,5	118	10,6
ASKP 400	400 mm ²	M20	5	330,00 ₺	115	50,6	33,5	21	25	36	190	160	9,8
ASKP 500	500 mm ²	M20	5	420,00 ₺	115	-	-	21	-	-	190	160	-

SIKMALI ALÜMİNYUM KABLO EK MUFLARI

COMPRESSIVE ALUMINIUM CABLE CONNECTORS

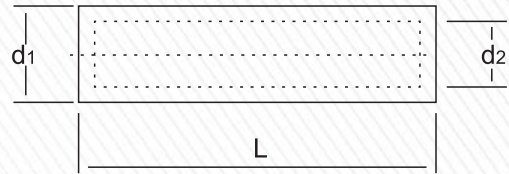

KOD CODE	KESİT CROSS SECTION	KUTU / ADET UNIT / BOX	FİYAT PRICE	L (mm)	d1 (mm)	d2 (mm)	d1-d2/2 (mm)
ASEM 16	16 mm ²	400	11,85 ₺	60	10	5,6	2,2
ASEM 25	25 mm ²	250	17,10 ₺	70	11,5	7	2,25
ASEM 35	35 mm ²	200	24,00 ₺	76	14	8,2	2,9
ASEM 50	50 mm ²	150	32,00 ₺	83	16	10	3
ASEM 70	70 mm ²	100	38,00 ₺	97	18	11,5	3,25
ASEM 95	95 mm ²	75	68,00 ₺	109	21	13,5	3,75
ASEM 120	120 mm ²	50	80,00 ₺	109	22	15	3,5
ASEM 150	150 mm ²	35	110,00 ₺	118,5	25	16,5	4,25
ASEM 185	185 mm ²	25	125,00 ₺	125,5	28	18,5	4,75
ASEM 240	240 mm ²	18	185,00 ₺	141,5	32	21,2	5,4
ASEM 300	300 mm ²	12	220,00 ₺	143	34	24,5	4,75
ASEM 400	400 mm ²	10	295,00 ₺	150	36	25	5,5
ASEM 500	500 mm ²	5	490,00 ₺	162	40	27,5	6,25

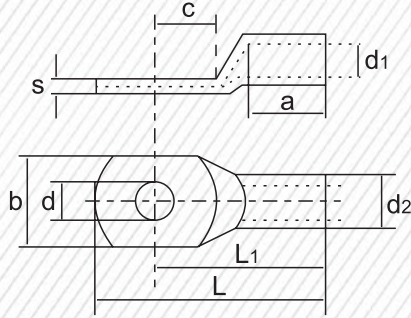

KOD CODE	KABLO KESİTİ CROSS SECTION	BAĞLANTI SCREW DIAMETER	FİYAT PRICE	KUTU/ADET UNIT/BOX	a (mm)	b (mm)	c1 (mm)	d (mm)	d1 (mm)	d2 (mm)	L (mm)	L1 (mm)
SKPD 10	10 mm ²	M 6	8,85 ₺	1000	10	9	7,5	6,4	4,5	6	27	34,5
SKPD 16	16 mm ²	M 8	28,00 ₺	400	20	13	10	8,4	5,5	8,5	36	46
SKPD 25	25 mm ²	M 8	35,00 ₺	250	20	16	10	8,4	7	10	38	48
SKPD 35	35 mm ²	M 10	66,50 ₺	200	20	19	12	10,5	8,2	12,5	42	54
SKPD 50	50 mm ²	M 10	100,00 ₺	150	28	22	12	10,5	10	14,5	52	64
SKPD 70	70 mm ²	M 12	133,00 ₺	100	28	24	13	13	11,5	16,5	55	68
SKPD 95	95 mm ²	M 12	198,00 ₺	75	35	28	13	13	13,5	19	65	78
SKPD 120	120 mm ²	M 12	245,00 ₺	50	35	32	16	13	15,5	21	70	86
SKPD 150	150 mm ²	M 12	350,00 ₺	35	35	34	16	13	17	23,5	78	94
SKPD 185	185 mm ²	M 16	400,00 ₺	25	40	37	19	17	19	25,5	82	101
SKPD 240	240 mm ²	M 16	580,00 ₺	18	40	42	19	17	21,5	29	92	111

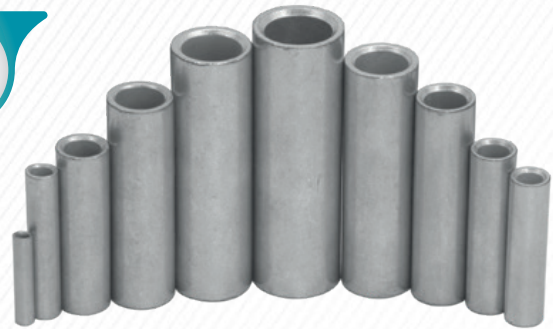
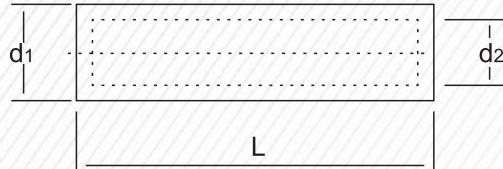

DIN NORM SIKMALI EK MUFLARI

DIN NORM COMPRESSIVE CONNECTORS

KOD CODE	KABLO KESİTİ CROSS SECTION	FİYAT PRICE	KUTU/ADET UNIT/BOX	L (mm)	d1 (mm)	d2 (mm)	D1-D2/2 (mm)
SEMD 10	10	9,60 ₺	1000	30,8	4,5	6	0,75
SEMD 16	16	33,25 ₺	400	50	5,5	8,5	1,5
SEMD 25	25	40,50 ₺	250	50	7	10	1,5
SEMD 35	35	68,50 ₺	200	50	8,2	12,5	2,15
SEMD 50	50	94,00 ₺	150	56	10	14,5	2,25
SEMD 70	70	119,00 ₺	100	56	11,5	16,5	2,5
SEMD 95	95	186,00 ₺	75	70	13,5	19	2,75
SEMD 120	120	210,00 ₺	50	70	15,5	21	2,75
SEMD 150	150	317,00 ₺	35	80	17	23,5	3,25
SEMD 185	185	367,50 ₺	25	85	19	25,5	3,25
SEMD 240	240	510,00 ₺	18	90	21,5	29	3,75

BİMETAL SIKMALI KABLO PABUCU

BIMETAL COMPRESSIVE LUG

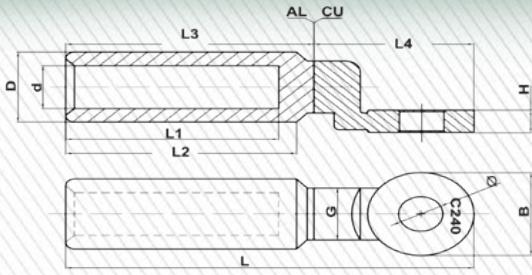

KOD CODE	KESİT CROSS SECTION	BAĞLANTI SCREW DIAMETER	FİYAT PRICE	D (mm)	d (mm)	L±2 (mm)	L1±1 (mm)	L2±1.5 (mm)	L3 (mm)	L4 (mm)	B (mm)	H (mm)
BTSKP 16	16 mm ²	M 8	4,75 \$	16	5,5	82	38	48	52	30	20	4
BTSKP 25	25 mm ²	M 8	4,75 \$	16	6,5	82	38	48	52	30	20	4
BTSKP 35	35 mm ²	M 8	4,75 \$	16	8,2	82	38	48	52	30	20	4
BTSKP 50	50 mm ²	M 10	6,25 \$	20	9,7	88	43	48	52	36	24	5
BTSKP 70	70 mm ²	M 10	6,25 \$	20	11	88	43	48	52	36	24	5
BTSKP 95	95 mm ²	M 10	6,25 \$	20	12,5	88	43	48	52	36	24	5
BTSKP 120	120 mm ²	M 12	9,65 \$	25	13,7	110	60	64	68	44	30	6
BTSKP 150	150 mm ²	M 12	9,65 \$	25	15,5	110	60	64	68	44	30	6
BTSKP 185	185 mm ²	M 12	15,90 \$	32	17,5	120	60	64	70	50	35	8
BTSKP 240	240 mm ²	M 12	15,90 \$	32	19,5	120	60	64	70	50	35	8
BTSKP 300	300 mm ²	M 12	26,00 \$	40	23	160	93	101	108	52	36	8
BTSKP 400	400 mm ²	M 12	26,00 \$	40	26,2	160	93	101	108	52	36	8

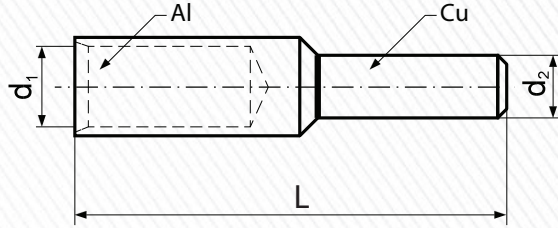

BİMETAL SIKMALI EK MUF

BIMETALLIC COMPRESSIVE CONNECTORS

KOD CODE	KESİT CROSS SECTION	FİYAT PRICE	d1 (mm)	d2 (mm)	L (mm)
BTSEM 35-16	35-16 mm ²	3,00 \$	8,5	7,0	85,0
BTSEM 50-25	50-25 mm ²	3,75 \$	9,8	8,5	90,0
BTSEM 70-35	70-35 mm ²	5,10 \$	11,5	9,8	100,0
BTSEM 95-50	95-50 mm ²	7,50 \$	13,5	11,5	110,0
BTSEM 120-70	120-70 mm ²	8,40 \$	15,0	13,5	110,0
BTSEM 150-95	150-95 mm ²	10,00 \$	16,5	15,0	115,0
BTSEM 185-120	185-120 mm ²	12,85 \$	18,5	16,5	125,0
BTSEM 240-150	240-150 mm ²	19,80 \$	21,0	18,5	130,0



BİMETAL PIN

BIMETALLIC PIN

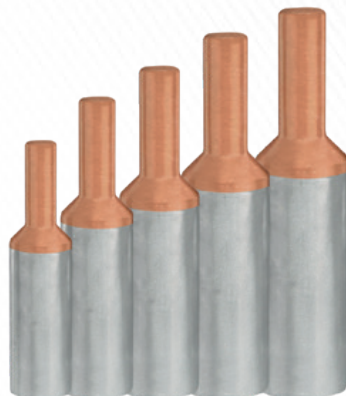

KOD CODE	KESİT CROSS SECTION	FİYAT PRICE
BTPİN 10	10 mm	3,95 \$
BTPİN 16	16 mm	3,95 \$
BTPİN 25	25 mm	4,00 \$
BTPİN 35	35 mm	4,50 \$
BTPİN 50	50 mm	5,40 \$
BTPİN 70	70 mm	5,90 \$
BTPİN 95	95 mm	8,25 \$
BTPİN 120	120 mm	9,85 \$
BTPİN 150	150 mm	10,20 \$
BTPİN 185	185 mm	13,45 \$
BTPİN 240	240 mm	15,05 \$
BTPİN 300	300 mm	17,95 \$

MEKANİK SIKMALI EK MUFLAR BOLTED CONNECTORS

KOD CODE	FİYAT PRICE	KABLO KESİTİ CROSS SECTION (mm ²)	DIŞ ÇAP OUTER D. (mm)	VİDA SAYISI BOLT NUMBER	KUTU/ADET UNIT/BOX
MSEM 25-95/2	14,00 \$	25-95	24	2	40
MSEM 35-150/4	27,00 \$	35-150	28	4	20
MSEM 70-240/4	38,00 \$	70-240	33	4	15
MSEM 120-300/4	54,00 \$	120-300	38	4	10
MSEM 185-400/4	70,00 \$	185-400	42	4	9
MSEM 500-630/6	119,00 \$	500-630	52	6	4
MSEM1 10-35/2	7,00 \$	16-35	16	2	40
MSEM1 25-50/2	11,00 \$	25-50	18	2	20
MSEM1 50-95/2	15,00 \$	50-95	22	2	15
MSEM1 120-185/2	19,50 \$	120-185	30	2	10
MSEM1 240-300/4	42,75 \$	240-300	36	4	9

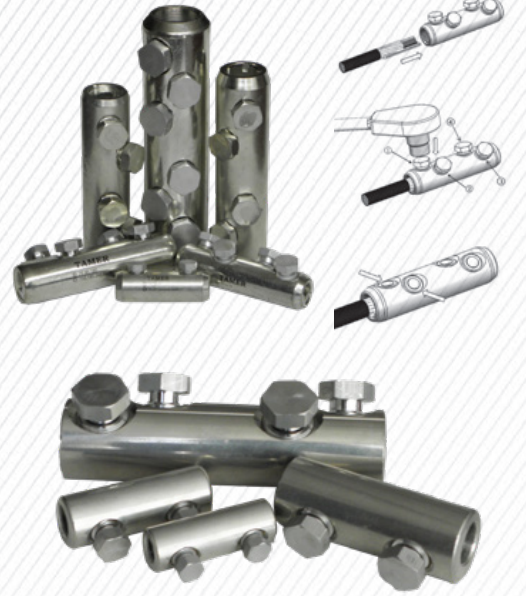

MEKANİK SIKMALI KABLO PABUCU BOLTED LUG

KOD CODE	FİYAT PRICE	KABLO KESİTİ CROSS SECTION (mm ²)	DIŞ ÇAP OUTER D. (mm)	VİDA SAYISI BOLT NUMBER	KUTU/ADET UNIT/BOX
MSKP 25-95-12/2	16,00 \$	25-95	24	2	40
MSKP 35-150-12/2	22,50 \$	35-150	28	2	20
MSKP 70-240-12/2	32,00 \$	70-240	33	2	12
MSKP 120-300-16/2	40,50 \$	120-300	38	2	9
MSKP 185-400-16/2	59,00 \$	185-400	42	2	7



BİMETAL MEKANİK SIKMALI KABLO PABUCU BIMETALLIC BOLTED LUG

KOD CODE	FİYAT PRICE	KABLO KESİTİ CROSS SECTION (mm ²)	DIŞ ÇAP OUTER D. (mm)	VİDA SAYISI BOLT NUMBER	KUTU/ADET UNIT/BOX
BMSKP 35-150-12/2	30,00 \$	35-150	28	2	80
BMSKP 70-240-12/2	40,00 \$	70-240	33	2	48
BMSKP 120-300-12/2	55,00 \$	120-300	38	2	36
BMSKP 185-400-16/2	99,00 \$	185-400	42	2	28

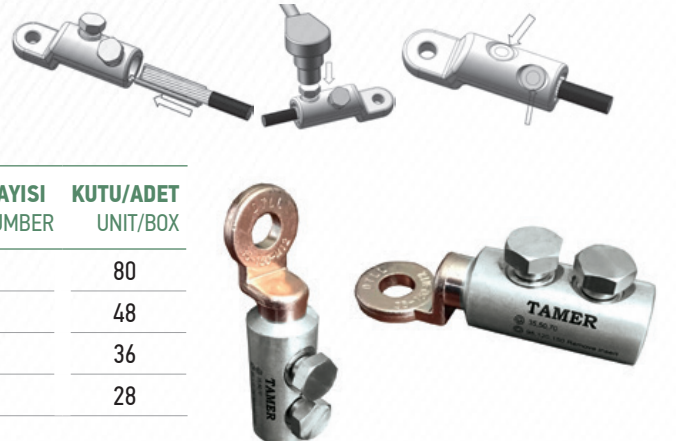

VİDALI KLEMENSLER SCREWED CONNECTORS

KOD CODE	KABLO KESİTİ CROSS SECTION (mm ²)	UZUNLUK LENGTH (mm)	ÇAP DIAMETER (mm)	FİYAT PRICE
VK 01	1,5 - 6	28	4,5	14,35 ₺
VK 02	10 - 16	50	5,5	20,00 ₺
VK 03	25	50	7	26,00 ₺
VK 04	35	56	8,5	32,25 ₺
VK 05	50	55	10	40,00 ₺
VK 06	70	60	12	46,00 ₺

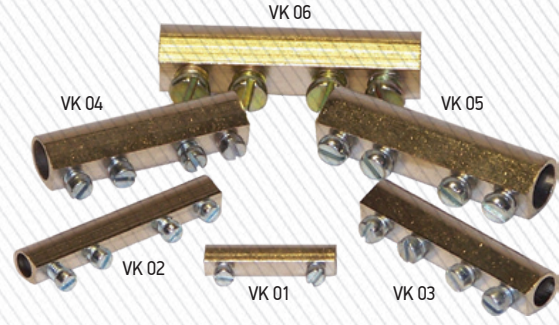

C- H KLEMENSLER C - H TYPE CONNECTORS

KOD CODE	KABLO KESİTİ CROSS SECTION (mm ²)	UZUNLUK LENGTH (mm)	ÇAP DIAMETER (mm)	FİYAT PRICE
CK 01	6 - 10 - 16	18	12	75,00 ₺
CK 02	25 - 35	27	20	104,00 ₺
CK 03	50 - 70 - 95	32	25	132,00 ₺
HK 01	50 - 95	30	22	155,00 ₺

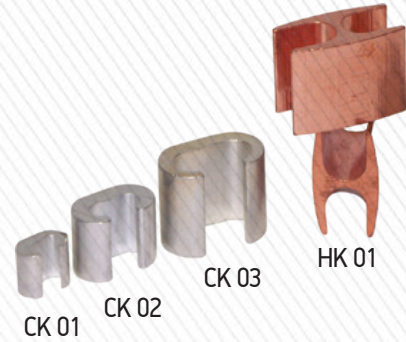

SERFİL KLEMENSLER SERFIL CONNECTORS

KOD CODE	KABLO KESİTİ CROSS SECTION (mm ²)	UZUNLUK LENGTH (mm)	ÇAP DIAMETER (mm)	FİYAT PRICE
SK 16	16	25	3	74,00 ₺
SK 25	25	26	4	83,00 ₺
SK 35	35	28,5	5	86,00 ₺
SK 50	50	30	8	90,00 ₺
SK 70	70	32,5	8	129,00 ₺
SK 95	95	34,5	11	135,00 ₺
SK 120	120	38	12	138,00 ₺
SK 150	150	42	11	187,00 ₺
SK 185	185	48	16	245,00 ₺
SK 240	240	53	20	325,00 ₺

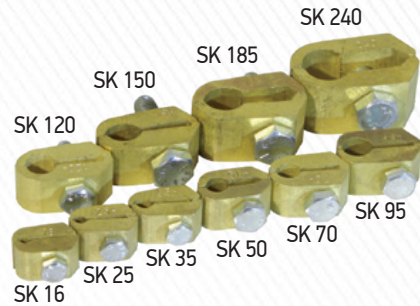

AG REÇİNELİ YALITIM BORULARI
L.V. ADHESIVE LINED INSULATION TUBES

0.6-1 kV



KOD CODE	(a) DARALMA ÖNCESİ BEFORE EXPANDED (mm) Φ	(b) DARALMA SONRASI AFTER EXPANDED (mm) Φ	(L) UZUNLUK LENGTH (m)	FIYAT PRICE (m/₺)
TIB 9/3	9	3	1,2	55,00 ₺
TIB 12/4	12	4	1,2	110,00 ₺
TIB 16/5	16	5	1,2	125,00 ₺
TIB 22/6	22	6	1,2	140,00 ₺
TIB 25/8	25	8	1,2	170,00 ₺
TIB 28/8	28	8	1,2	170,00 ₺
TIB 33/10	33	10	1,2	190,00 ₺
TIB 40/12	40	12	1,2	240,00 ₺
TIB 45/15	45	15	1,2	260,00 ₺
TIB 54/18	54	18	1,2	290,00 ₺
TIB 60/19	60	19	1,2	330,00 ₺
TIB 65/22	65	22	1,2	400,00 ₺
TIB 75/22	75	22	1,2	430,00 ₺
TIB 80/30	80	30	1,2	470,00 ₺
TIB 90/30	90	30	1,2	500,00 ₺
TIB 105/33	105	33	1,2	540,00 ₺
TIB 125/40	130	40	1,5	695,00 ₺
TIB 140/40	140	40	1,5	750,00 ₺
TIB 150/50	150	50	1,5	1.050,00 ₺
TIB 170/58	170	58	1,5	1.900,00 ₺



OG BARA İZOLASYON BORULARI M.V. BUSBAR INSULATION TUBES

36 kV



KOD CODE	(a) DARALMA ÖNCESİ BEFORE EXPANDED (mm) Ø	(b) DARALMA SONRASI AFTER EXPANDED (mm) Ø	(L) UZUNLUK LENGTH (m)	FİYAT PRICE (m/₺)
TAIB 21/7	21	7	1,2 veya (25m/rulo)	490,00 ₺
TAIB 33/10	33	10	1,2 veya (25m/rulo)	550,00 ₺
TAIB 38/12	38	12	1,2 veya (25m/rulo)	580,00 ₺
TAIB 45/17	45	17	1,2 veya (25m/rulo)	630,00 ₺
TAIB 54/18	54	18	1,2 veya (25m/rulo)	660,00 ₺
TAIB 60/22	60	22	1,2 veya (25m/rulo)	700,00 ₺
TAIB 65/22	65	22	1,2	700,00 ₺
TAIB 75/22	75	22	1,2	700,00 ₺
TAIB 90/30	90	30	1,2	840,00 ₺
TAIB 110/40	110	40	1,2	890,00 ₺
TAIB 125/40	125	40	1,2	890,00 ₺
TAIB 140/40	140	40	1,5	890,00 ₺
TAIB 160/50	160	50	1,5	1.350,00 ₺

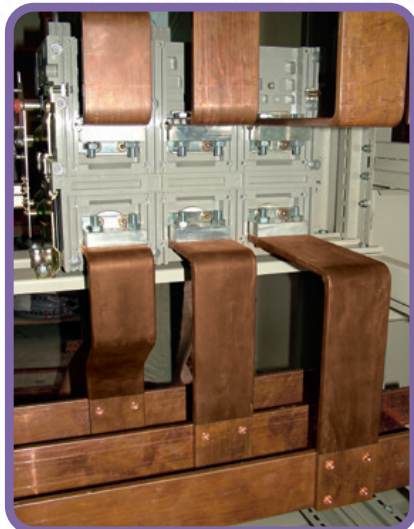

0.6-1 kV



KOD CODE	(a) DARALMA ÖNCESİ BEFORE EXPANDED (mm) Φ	(b) DARALMA SONRASI AFTER EXPANDED (mm) Φ	(L) UZUNLUK LENGTH (m)	FİYAT PRICE (m/\$)
TFB 38/12	38	12	1	39,00 \$
TFB 50/18	50	18	1	41,00 \$
TFB 65/22	65	22	1	45,00 \$
TFB 80/30	80	30	1	52,00 \$
TFB 100/35	100	35	1	55,00 \$
TFB 120/40	120	40	1	60,00 \$

UÇ KORUYUCULAR

ADHESIVE LINED END CAPS

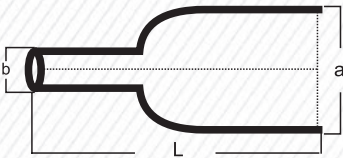

KOD CODE	(a) DARALMA ÖNCESİ BEFORE EXPANDED (mm) Φ	(b) DARALMA SONRASI AFTER EXPANDED (mm) Φ	(L) UZUNLUK LENGTH (mm)	FİYAT PRICE (Adet/ PCS)
UK 11/5	11	5,5	22	49,00 ₺
UK 16/7	16	7,5	75	70,00 ₺
UK 25/10	25	10,5	80	80,00 ₺
UK 32/16	32	16,5	90	90,00 ₺
UK 50/26	50	26	115	110,00 ₺
UK 70/37	70	37	120	135,00 ₺
UK 100/46	100	46	140	165,00 ₺
UK 120/57	120	57	155	190,00 ₺



Isı Büzüşmeli İzolasyon Boruları



ANA KOD MAIN CODE	KOD CODE	Siyah Black (m/\$)	KOD CODE	Sarı- Yeşil Yellow/ Green (m/\$)	KOD CODE	Kırmızı Red (m/\$)	KOD CODE	Sarı Yellow (m/\$)	KOD CODE	Mavi Blue (m/\$)	KOD CODE	Yeşil Green (m/\$)
MAK 1,5	MAK 01.511	0,075	MAK 01.512	0,360	MAK 01.513	0,089	MAK 01.514	0,089	MAK 01.515	0,089	MAK 01.516	0,089
MAK 2,5	MAK 02.511	0,118	MAK 02.512	0,323	MAK 02.513	0,130	MAK 02.514	0,130	MAK 02.515	0,130	MAK 02.516	0,130
MAK 3,5	MAK 03.511	0,133	MAK 03.512	0,330	MAK 03.513	0,165	MAK 03.514	0,165	MAK 03.515	0,165	MAK 03.516	0,165
MAK 4,5	MAK 04.511	0,170	MAK 04.512	0,339	MAK 04.513	0,210	MAK 04.514	0,210	MAK 04.515	0,210	MAK 04.516	0,210
MAK 5	MAK 05.011	0,190	MAK 05.012	0,348	MAK 05.013	0,217	MAK 05.014	0,217	MAK 05.015	0,217	MAK 05.016	0,217
MAK 6	MAK 06.011	0,220	MAK 06.012	0,380	MAK 06.013	0,252	MAK 06.014	0,252	MAK 06.015	0,252	MAK 06.016	0,252
MAK 7	MAK 07.011	0,245	MAK 07.012	0,451	MAK 07.013	0,273	MAK 07.014	0,273	MAK 07.015	0,273	MAK 07.016	0,273
MAK 8	MAK 08.011	0,250	MAK 08.012	0,510	MAK 08.013	0,290	MAK 08.014	0,290	MAK 08.015	0,290	MAK 08.016	0,290
MAK 10	MAK 1011	0,300	MAK 1012	0,540	MAK 1013	0,358	MAK 1014	0,358	MAK 1015	0,358	MAK 1016	0,358
MAK 12	MAK 1211	0,360	MAK 1212	0,750	MAK 1213	0,420	MAK 1214	0,420	MAK 1215	0,420	MAK 1216	0,420
MAK 13	MAK 1311	0,380	MAK 1312	0,800	MAK 1313	0,430	MAK 1314	0,430	MAK 1315	0,430	MAK 1316	0,430
MAK 16	MAK 1611	0,580	MAK 1612	1,150	MAK 1613	0,683	MAK 1614	0,683	MAK 1615	0,683	MAK 1616	0,683
MAK 18	MAK 1811	0,760	MAK 1812	1,525	MAK 1813	1,150	MAK 1814	1,150	MAK 1815	1,150	MAK 1816	1,150
MAK 2011	MAK 2011	0,980	MAK 2012	1,609	MAK 2013	1,210	MAK 2014	1,210	MAK 2015	1,210	MAK 2016	1,210
MAK 2211	MAK 2211	1,220	MAK 2212	1,834	MAK 2213	1,420	MAK 2214	1,420	MAK 2215	1,420	MAK 2216	1,420
MAK 25	MAK 2511	1,250	MAK 2512	2,100	MAK 2513	1,478	MAK 2514	1,478	MAK 2515	1,478	MAK 2516	1,478
MAK 28	MAK 2811	1,650	MAK 2812	2,440	MAK 2813	1,995	MAK 2814	1,995	MAK 2815	1,995	MAK 2816	1,995
MAK 30	MAK 3011	1,690	MAK 3012	2,660	MAK 3013	2,050	MAK 3014	2,050	MAK 3015	2,050	MAK 3016	2,050
MAK 32	MAK 3211	2,100	MAK 3212	2,950	MAK 3213	2,100	MAK 3214	2,100	MAK 3215	2,100	MAK 3216	2,100
MAK 35	MAK 3511	2,100	MAK 3512	3,690	MAK 3513	2,950	MAK 3514	2,950	MAK 3515	2,950	MAK 3516	2,950
MAK 38	MAK 3811	2,400	MAK 3812	3,950	MAK 3813	3,055	MAK 3814	3,055	MAK 3815	3,055	MAK 3816	3,055
MAK 40	MAK 4011	2,300	MAK 4012	4,440	MAK 4013	3,310	MAK 4014	3,310	MAK 4015	3,310	MAK 4016	3,310
MAK 45	MAK 4511	2,850	MAK 4512	5,100	MAK 4513	3,594	MAK 4514	3,594	MAK 4515	3,594	MAK 4516	3,594
MAK 50	MAK 5011	3,000	MAK 5012	5,550	MAK 5013	3,750	MAK 5014	3,750	MAK 5015	3,750	MAK 5016	3,750
MAK 60	MAK 6011	4,050	MAK 6012	8,000	MAK 6013	4,700	MAK 6014	4,700	MAK 6015	4,700	MAK 6016	4,700
MAK 70	MAK 7011	5,360	MAK 7012	10,440	MAK 7013	6,752	MAK 7014	6,752	MAK 7015	6,752	MAK 7016	6,752
MAK 80	MAK 8011	5,950	MAK 8012	11,750	MAK 8013	7,000	MAK 8014	7,000	MAK 8015	7,000	MAK 8016	7,000
MAK 90	MAK 9011	6,700	MAK 9012	15,900	MAK 9013	8,756	MAK 9014	8,756	MAK 9015	8,756	MAK 9016	8,756
MAK 100	MAK 10011	7,400	MAK 10012	18,100	MAK 10013	10,250	MAK 10014	10,250	MAK 10015	10,250	MAK 10016	10,250
MAK 120	MAK 12011	10,300	MAK 12012	23,000	MAK 12013	14,465	MAK 12014	14,465	MAK 12015	14,465	MAK 12016	14,465
MAK 150	MAK 15011	15,000	MAK 15012	32,000	MAK 15013	18,400	MAK 15014	18,400	MAK 15015	18,400	MAK 15016	18,400



0.6-1 kV

AG ISI BÜZÜŞMELİ MAKARONLAR

LV HEAT SHRINKABLE THIN WALL TUBES

KOD CODE	Gri Grey (m/\$)	KOD CODE	Kahve Brown (m/\$)	DARALMA ÖNCESİ Before Expanded (mm)	DARALMA SONRASI After Expanded (mm)	BARAYA UYGUNLUK Busbar Eligibility	KABLOYA UYGUNLUK Cable Eligibility (1kV NYY Kablolar içindir -For NYY Cables)	Kablo Pabucuna Uygunluk Cable Lug Eligibility	PAKET Rulo Packing (m)
MAK 01.517	0,089	MAK 01.518	0,089	1,5	0,75				200
MAK 02.517	0,130	MAK 02.518	0,130	2,5	1,25				200
MAK 03.517	0,165	MAK 03.518	0,165	3,5	1,75				200
MAK 04.517	0,210	MAK 04.518	0,210	4,5	2,25				100
MAK 05.017	0,217	MAK 05.018	0,217	5	2,5				100
MAK 06.017	0,252	MAK 06.018	0,252	6	3				100
MAK 07.017	0,273	MAK 07.018	0,273	7	3,5				100
MAK 08.017	0,290	MAK 08.018	0,290	8	4				100
MAK 1017	0,358	MAK 1018	0,358	10	5			6-10	100
MAK 1217	0,420	MAK 1218	0,420	12	6		1x10,1x16	6-10	100
MAK 1317	0,430	MAK 1318	0,430	13	6,5	12X2-15X2-15X3	1x10,1x16,1x25,	16-25	100
MAK 1617	0,683	MAK 1618	0,683	16	8	20X2-20X3	1x16,1x25,1x35,1x50	16-25-35-50	100
MAK 1817	1,150	MAK 1818	1,150	18	9	20X5	1x25,1x35,1x50,1x70	35-50	100
MAK 2017	1,210	MAK 2018	1,210	20	10	20X5-25X3-25X5	1x25,1x35,1x50,1x70,1x95,2x10,3x10	70	100
MAK 2217	1,420	MAK 2218	1,420	22	11	25X5-30X3-30X5	1x35,1x50,1x70,1x95,1x120,2x10,2x16,,3x10,3x16,4x10	70-95	100
MAK 2517	1,478	MAK 2518	1,478	25	12,5	25X5-30X3-30X5	1x50,1x70,1x95,1x120,1x150,1x185,2x10, 2x16,2x25,3x10,3x16,4x10,4x16	70-95	50
MAK 2817	1,995	MAK 2818	1,995	28	14	40X3	1x95,1x120,1x150,2x10,2x16,2x25,2x35,3x10, 3x16,3x25,3x35,4x10,4x16,4x25	70-95	50
MAK 3017	2,050	MAK 3018	2,050	30	15	40X3-40X5	1x95,1x120,1x150,1x185,1x240,2x10,2x16,2x25,2x35, 2x50,3x10,3x16,3x25,3x35,4x10,4x16,4x25	120	50
MAK 3217	2,100	MAK 3218	2,100	32	16	30X10-40X5	1x95,1x120,1x150,1x185,1x240,1x300,2x16,2x25,2x35, 2x50,3x10,3x16,3x25,3x35,3x50,4x10,4x16,4x25,4x35	120-150	50
MAK 3517	2,950	MAK 3518	2,950	35	17,5	30X10-40X5- 40X10	1x120,1x150,1x185,1x240,1x300,2x16,2x25,2x35, 2x50,2x70,3x16,3x25,3x35,3x70,4x10,4x16,4x25,4x35,4x50	150	50
MAK 3817	3,055	MAK 3818	3,055	38	19	40X5-40X10	1x150,1x185,1x240,1x300,1x400,2x25,2x35, 2x50,2x70,2x95,3x25,3x35,3x50,4x16,4x25	185-240	50
MAK 4017	3,310	MAK 4018	3,310	40	20	50X5	1x185,1x240,1x300,2x25,2x35,2x50,2x70,2x95,3x25, 3x35,3x50,3x70,3x95,4x16,4x25,4x35,4x50,4x70	185-240-300	50
MAK 4517	3,594	MAK 4518	3,594	45	22,5	50X5-50X10	1x240,1x300,1x400,2x35,2x50,2x70,2x95,2x120,2x150,3x25, 3x35,3x50,3x70,3x95,3x120,4x25,4x35,4x50,4x70,4x95	240-300-400	25
MAK 5017	3,750	MAK 5018	3,750	50	25	60X5-60X10	1x240,1x300,1x400,2x50,2x70,2x95,2x120,2x150,2x185, 3x50,3x70,3x95,3x150,4x35,4x50,4x70,4x95,4x120	400	25
MAK 6017	4,700	MAK 6018	4,700	60	30	80X5-80X10	1x400,2x95,2x120,2x150,2x185,2x240,3x70,3x95,3x120, 3x150,3x185,3x240,4x50,4x70,4x95,4x120,4x150,4x185		25
MAK 7017	6,752	MAK 7018	6,752	70	35	100X5-100X10	2x120,2x150,2x185,2x240,2x300,3x95,3x120,3x150,3x185, 3x240,3x300,4x70,4x95,4x120,4x150,4x185,4x240		25
MAK 8017	7,000	MAK 8018	7,000	80	40	100X5-100X10	2x150,2x185,2x240,2x300,3x120,3x150,3x185,3x240, 3x300,3x400,4x95,4x120,4x150,4x185,4x240,4x300		25
MAK 9017	8,756	MAK 9018	8,756	90	45	100X10	2x185,2x240,2x300,3x185,3x240,3x300, 3x400,4x150,4x185,4x240,4x300,4x400		25
MAK 10017	10,250	MAK 10018	10,250	100	50	120X10	2x240,2x300,3x240,3x300,3x400,4x185,4x240,4x300,4x400		25
MAK 12017	14,465	MAK 12018	14,465	120	60	120X10-160X10	3x300,3x400,4x240,4x300,4x400		25
MAK 15017	18,400	MAK 15018	18,400	150	75	160X10	4x400		25

ÖZEL BANTLAR
SPECIAL TAPES

0.6-36 kV



KOD CODE	CİNSİ TYPE	KALINLIK THICKNES (mm)	EN WIDTH (mm)	UZUNLUK LENGTH (m)	KUTU / ADET UNIT / BOX	FİYAT PRICE
PB 131910	Plastik Bant (0,6kV)	0,13	19	10	500	0,65 \$
PB 131925	Plastik Bant (0,6kV)	0,13	19	25	60	1,80 \$
PB 135025	Plastik Bant (0,6kV)	0,13	50	25	80	3,90 \$
TE 1401	Eriyen Bant (10kV)	0,76	19	8	60	3,25 \$
TE 1402	Eriyen Bant (10kV)	0,76	50	8	24	8,30 \$
TE 1403	Eriyen Bant (36kV)	0,76	19	8	60	8,50 \$
TE 1404	Yarı İletken Bant	0,75	19	5	96	9,50 \$

KOD CODE	CİNSİ TYPE	FİYAT PRICE
HYK 63	63 mm Huni Yan Kapak	27,50 ₺
HYK 75	75 mm Huni Yan Kapak	55,00 ₺
HYK 90	90 mm Huni Yan Kapak	110,00 ₺
HYK 100	100 mm Huni Yan Kapak	138,00 ₺
HYK 125	125 mm Huni Yan Kapak	165,00 ₺
KBH 01	Kablo Başlığı Hunisi	55,00 ₺
KBH 02	Kablo Başlığı Hunisi	70,00 ₺
KBH 03	Kablo Başlığı Hunisi	82,50 ₺
EMH 4205	4x2,5 -4x6 Ek Muf Hunisi (Takım)	82,50 ₺
EMH 63	4x10-4x16 Ek Muf Hunisi (Takım)	165,00 ₺
EMH 64	3x25+16- 3x50+25 Ek Muf Hunisi (Takım)	165,00 ₺
EMH 70 - 95	70-95mm Ek Muf Hunisi (Takım)	212,50 ₺
EMH 120-150	120-150mm Ek Muf Hunisi (Takım)	335,00 ₺
EMH 185-240	185-240mm Ek Muf Hunisi (Takım)	440,00 ₺

PLASTİK HUNİ KALIPLARI
PLASTIC FUNNEL MOULDS

EK MUF KALIPLARI

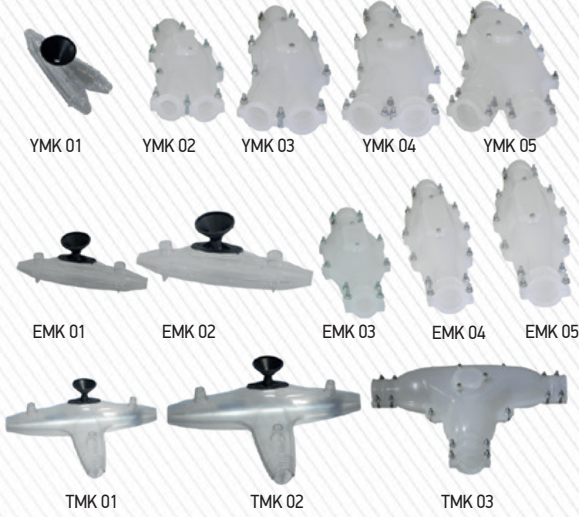
JOINT MOULDS



KOD CODE	CİNSİ TYPE	Uygun Kablo Kesiti	FİYAT PRICE
YMK 01	Y Branşman Ek Muf Kalıbı No: 1	1,5-10	195,00 ₺
YMK 02	Y Branşman Ek Muf Kalıbı No: 2	10-25	1.500,00 ₺
YMK 03	Y Branşman Ek Muf Kalıbı No: 3	35-70	1.900,00 ₺
YMK 04	Y Branşman Ek Muf Kalıbı No: 4	95-120	2.300,00 ₺
YMK 05	Y Branşman Ek Muf Kalıbı No: 5	150-240	2.900,00 ₺
EMK 01	Şeffaf Düz Ek Muf Kalıbı No: 1	10-25	215,50 ₺
EMK 02	Şeffaf Düz Ek Muf Kalıbı No: 2	35-95	285,00 ₺
EMK 03	Şeffaf Düz Ek Muf Kalıbı No: 3	10-25	1.200,00 ₺
EMK 04	Şeffaf Düz Ek Muf Kalıbı No: 4	35-70	1.660,00 ₺
EMK 05	Şeffaf Düz Ek Muf Kalıbı No: 5	95-240	2.200,00 ₺
TMK 01	T Branşman Ek Muf Kalıbı No: 1	10-25	450,00 ₺
TMK 02	T Branşman Ek Muf Kalıbı No: 2	35-95	648,00 ₺
TMK 03	T Branşman Ek Muf Kalıbı No: 3	120-240	2.290,00 ₺

KUŞKOVAR

BIRD SPIKES

KOD CODE	UZUNLUK LENGTH	FİYAT PRICE
TKUS 01	50 cm	
TKUS 02	50 cm	

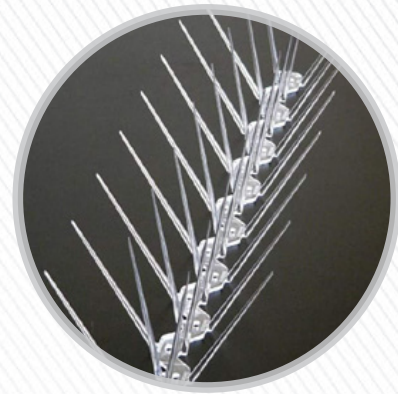

BUAT KAPAĞI

JUNCTION COVER

KOD CODE	GÖVDE ÇAPI MAIN DIAMETER (cm)	TIRNAK UZUNLUĞU LOCK OF LENGTH (cm)	KUTU / ADET UNIT / BOX	FİYAT PRICE
BK 01	9,1	8,3	250	20,00 ₺

36 kV EKSPANLI KABLO BAŞLIKLARI PLUG IN CABLE TERMINATION



KOD CODE	CİNSİ TYPE	KABLO KESİTİ CROSS SECTION (mm ²)	KABLO YALITKAN ÇAPI INSULATION DIAMETER OF CABLE (mm ²)	FİYAT PRICE
TLS36 35-70	L TİPİ	35-70	26-29	
TLS36 95-150		95-150	30-34	
TLS36 185-240		185-240	35-40	
TLS36 400-500		400-500	41-46	
TTS36 35-70	T TİPİ	35-70	26-29	
TTS36 95-150		95-150	30-34	
TTS36 185-240		185-240	35-40	
TTS36 400-500		400-500	41-46	

AG & OG YALITIM HALISI LV & MV INSULATION SHEET

KOD CODE	YALITIM DEĞERİ INSULATION RATE	FİYAT PRICE
TH06	1kV'a Kadar	
TH36	36kV'a Kadar	

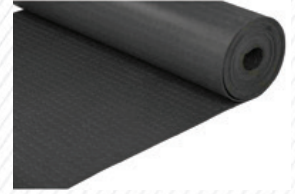

OG YALITIM SEHPASI MV INSULATION STAND

KOD CODE	YALITIM DEĞERİ INSULATION RATE	FİYAT PRICE
TS36	36kV'a Kadar	

OG YALITIM ELDİVENİ VE STANKA MV INSULATION GLOVE AND MANEUVER BAR

KOD CODE	CİNSİ TYPE	FİYAT PRICE
TE36 (Eldiven)	36kV'a Kadar	
TST36 (Stanka)	36kV'a Kadar	



DİKKAT ÖLÜM TEHLİKESİ UYARI LEVHASI WARNING SIGN

KOD CODE	CİNSİ TYPE	FİYAT PRICE
TLE36	Sarı Paslanmaz Metal Levha	

HAVAI HAT KİLİTLEME EL ALETİ OVERHEAD-LINE HAND TOOL

KOD CODE	CİNSİ TYPE	FİYAT PRICE
THK 2R	2 açılı, paslanmaz, kilitleme	4.900,00 ₺



OG KABLO SOYMA EL ALETİ MV CABLE STRIPPING HAND TOOL

KOD CODE	CİNSİ TYPE	FİYAT PRICE
TSEL01	Yarı İletken ve İzolasyon Soyma El Aleti	

TAMER ELEKTRİK
İMALAT SANAYİ TİCARET LİMİTED ŞİRKETİ

ŞUBE / BRANCH

Anafartalar Mah. Kuruçeşme Sk. No: 3/A-B Ulus - ANKARA / TÜRKİYE

Tel : +90 312 324 12 71 - 311 94 71 - 310 18 05

Fax : +90 312 324 45 74

ŞUBE / BRANCH

Elektrokent İş Merkezi 1467. Cad. No: 2/29

İvedik O.S.B. / Ostim / ANKARA / TÜRKİYE

Tel : +90 312 395 17 20 - 21 - 24

Fax : +90 312 395 17 23

ŞUBE/OSTİM KABLO MARKET / FACTORY / HEAD OFFICE

Elektrokent İş Merkezi 1467.Cad. No: 26/29 İvedik O.S.B.

Ostim - ANKARA / TÜRKİYE

Tel : +90 312 395 17 20 - 21- 24

Fax : +90 312 395 17 23

FABRİKA/MERKEZ / FACTORY / HEAD OFFICE

İstanbul Yolu 26. Km. Saray Mah. Saray Cad. No: 13

Kahramankazan - ANKARA / TÜRKİYE

Tel : +90 312 815 44 74 - 815 45 52

Fax : +90 312 815 45 53

www.tamerelektrik.com.tr

tamer@tamerelektrik.com.tr - info@tamerelektrik.com.tr

